

---

## **TABLE OF CONTENTS**

BACK PRESSURE REGULATORS .....	29
CGA CYLINDER CONNECTIONS AND GASKETS .....	108-109
CHANGEOVER MANIFOLDS .....	70-73, 76
CHECK VALVES .....	82
CUSTOM SYSTEMS .....	78-79
CYLINDER HAND TRUCKS .....	101
CYLINDER HEATER .....	61
CYLINDER HOLDING DEVICES .....	96-100
CYLINDER SCALES .....	64-65
DISS CONNECTIONS .....	109
EQUIPMENT TUTORIAL .....	2 and 3
EZ BRACKETS .....	85
FILTERS .....	54-60
FLASH ARRESTOR .....	66
FLOWMETERS.....	31-39
GAS DETECTION SYSTEMS .....	86-95
GAS HEATERS .....	60, 62-63
GAS PROPORTIONERS AND MIXERS.....	34-35
GAS STORAGE CABINETS .....	102
GAS TRAPS AND PURIFIERS .....	44-52
HOSES .....	104
LASER WELDING AND CUTTING EQUIPMENT .....	26-28
LEAK DETECTION FLUID .....	30
LECTURE BOTTLE EQUIPMENT .....	24-25
LOW PRESSURE GAS ALARM.....	77
MANIFOLDS .....	67-69
MANUAL CONTROLS.....	85
MASS FLOW CONTROLLERS .....	40-41
MASS FLOW METERS.....	42-43
MOLECULAR SIEVES .....	53
NUMERICAL INDEX.....	112
PRESSURE GAUGES .....	107
PRESSURE REGULATORS.....	4-24
PROTOCOL STATIONS .....	74-75
PURGE ASSEMBLIES .....	80-81
PURIFIERS.....	44-52
RELIEF VALVES .....	84
SCALES.....	64-65
SPARGERS .....	106
VALVES.....	82-83
WHISPER VALVE.....	105
WRENCHES .....	103

---

# A BRIEF TUTORIAL ON GAS HANDLING EQUIPMENT

## PRESSURE REGULATORS

Pressure regulators (often just called regulators) are used in a gas system to reduce the pressure from a high pressure source, such as a compressed gas cylinder or a gas supply pipeline, to a safe level consistent with the pressure rating of the system to which the gas is being supplied. They provide positive control of the source pressure in a gas system. This control of pressure permits better control of flow rates and helps to provide a safer operation.

There are two basic types of pressure regulators; two-stage and one-stage. The outward appearance of both types is very similar and it is often difficult for the novice to identify the two types.

Most two-stage and one-stage pressure regulators are fitted with two pressure gauges; one to monitor the inlet pressure and the other to monitor the delivery pressure. Line regulators and some regulators used on liquefied gases have only a delivery pressure gauge, because in these applications the inlet pressure is virtually constant. Historically, the compressed gas industry has established the convention of placing the inlet and high pressure gauge on the right and the low pressure and delivery pressure gauge on the left.

A pressure regulator **does not** control flow, but precise control of pressure is required for precise flow control. This is accomplished by the installation of a valve on the outlet side of the regulator in conjunction with a flowmeter or electronic mass flow controller.

**What is the difference between a two-stage and one-stage pressure regulator?** A two-stage regulator reduces the pressure in two steps. In the first stage the high pressure gas is reduced to a pre-set intermediate pressure level, then reduced again in the second stage to the manually adjusted value desired by the operator. This two step reduction provides steady gas delivery throughout the discharge of almost the full cylinder contents. This is why two-stage regulators are used whenever the discharge pressure of a system must be precisely maintained. Two-stage regulators are generally used whenever the compressed gas cylinder pressure exceeds 1000 psig. Cylinders having a pressure less than 1000 psig are generally fitted with a one-stage regulator since the advantage of the two-stage regulator is minimized by the lower inlet pressure.

One-stage regulators perform the same service as two-stage regulators, but in one step. Thus, the discharge pressure is not controlled with the same precision, because the discharge pressure will vary widely over the full range of cylinder pressures unless periodic adjustments are made to compensate for decreasing inlet pressures. One-stage regulators are economic alternatives in applications where precise control is not required or usage is intermittent over the life time of the source cylinder.

## RELIEF VALVES

Relief valves are installed in systems or regulators to protect against over pressurization of system components that are not capable of withstanding the higher pressures that could enter the protected region upon the failure of another system component or an operator error. Relief valves are generally offered in two types, adjustable or fixed pressure. Adjustable units can be set by the user at different pressures within a reasonably wide range. Fixed pressure units are preset at the factory for one pressure and cannot easily be changed.

## PURGE DEVICES

Purge devices are valving systems usually installed on the inlet side of a pressure regulator, to maintain the integrity of a high purity gas system, remove toxic or corrosive residual gases from the regulator inlet, and/or protect the operator from exposure during cylinder changeovers or system shut-downs.

## MANUAL CONTROLS

Manual controls are valves that have been designed for direct connection to a compressed gas cylinder valve outlet. They provide a simple means of transferring the contents of a cylinder to another system or vessel. They **do not control pressure** and should never be used without an operator in attendance at all times. A safety relief device should be installed in any system employing a manual control.

## FLOWMETERS

Flowmeters are used in fluid systems to indicate the rate of flow of the fluid. They do not control the rate of flow unless they are equipped with a valve or flow controller. Rotameters and electronic mass flowmeters are the two basic types of flow measuring devices available. For more specific information see pages 31-39.

## PURIFIERS

Purifiers are devices that are designed to remove specific impurities or components from a gas stream. They generally function by adsorption or catalytic action. Some are designed as housings that accept replaceable cartridges containing the adsorbing materials, others are sealed units that are replaced completely, while others require no replacement or can be regenerated in place.

## PARTICULATE FILTERS

Gas line filters are devices designed to remove particles from the gas stream in which they are installed. The size of the particles removed is determined by the filter media used. A filter's rating is usually expressed in microns, referring to the maximum size diameter that will pass through the filter.

## VALVES

There are two basic types of valves used with gases; diaphragm packless and packed. Diaphragm, packless valves are used for on/off control or rough flow control in high purity applications. They are designed using a metal diaphragm to seal the gas cavity from the valve stem threads. Packed valves are designed with a packing gland that creates a seal on the valve stem. This packing may be above or below the threads of the valve, depending on the intended application.

## CYLINDER SCALES

A cylinder scale is used to monitor the contents of a liquefied gas cylinder feeding a critical batch operation where a lack of gas during the run would cause the batch to fail. Cylinder scales are designed to provide a positive indication of the amount of product remaining in the cylinder. Two types are generally offered, mechanical and electronic. Electronic scales offer the added benefit of a low weight alarm and relay contacts to operate accessory equipment. Both types are offered in this catalog.

## pressure regulator component designations

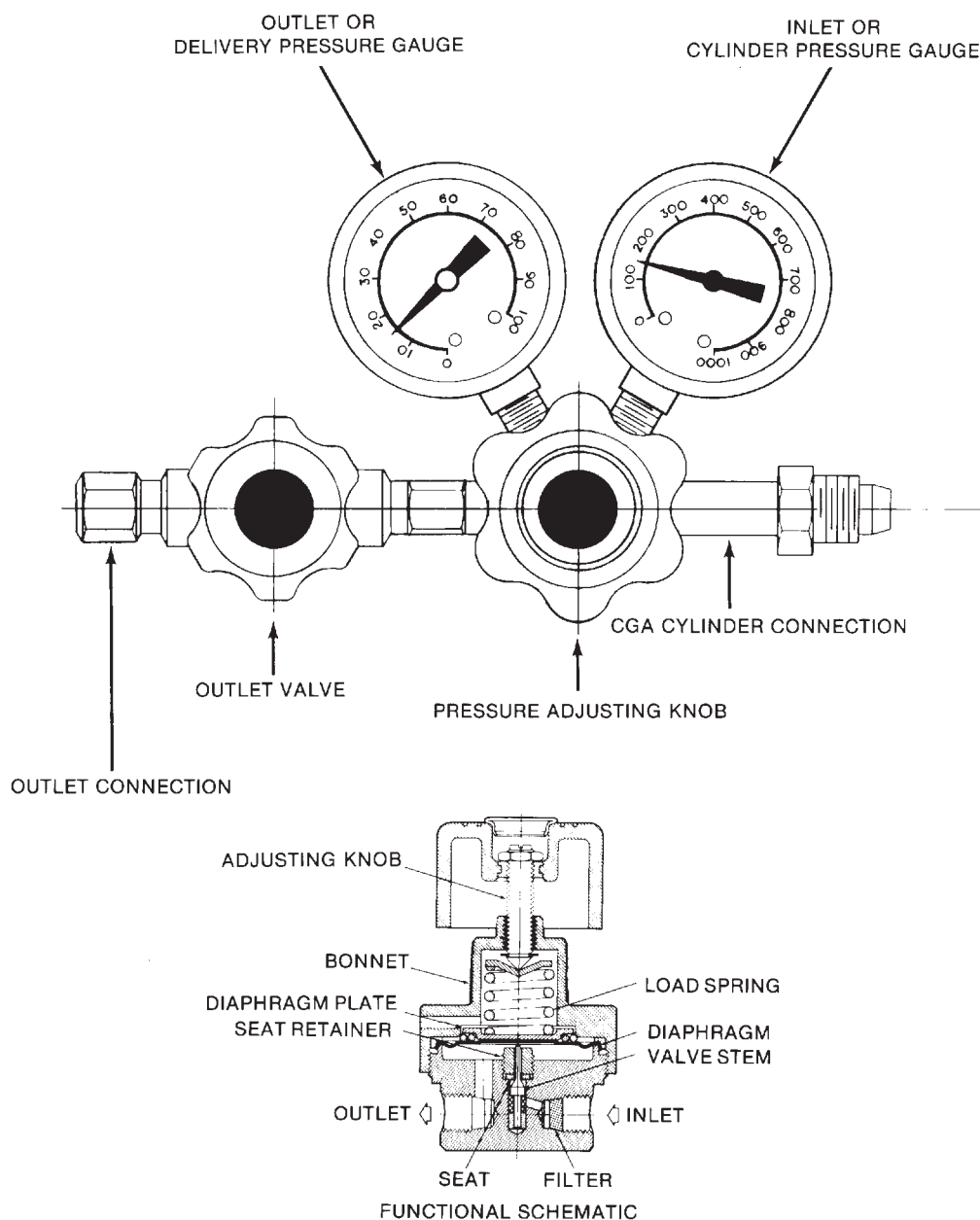

# BRASS HIGH PURITY 1-STAGE REGULATOR Series 3100

## DESCRIPTION

The Series 3100 single stage regulators are designed and constructed for both high purity, low volume use and general purpose applications. They provide outstanding performance, yet they are rugged and versatile enough for the laboratory or plant. The relative low cost of these units has established them as the pressure regulator of choice in many plants and laboratories.

## FEATURES

- Small internal volume - less than 6 cc.
- High purity diffusion resistant, metal diaphragm construction.
- Diffusion resistant, brass diaphragm packless control valve installed on outlet as standard.
- Designed to pass an inboard helium leak-rate test of  $1 \times 10^{-9}$  cc per sec.
- All parts ultrasonically cleaned prior to assembly.

## APPLICATIONS

The 3100 Series regulators are ideally suited for use with small cylinders of Research Purity or Ultra High Purity gases. The small internal volume and high purity design result in more efficient use of expensive materials because it takes less gas to fill the internal cavity. They are also useful for less critical pressure reduction applications, where the precise control of pressure or flow is not required.



## SPECIFICATIONS

Max. Inlet Pressure: 3000 psig  
 Operating Temp. Range: -40° to +185°F.  
 Flow Coefficient ( $C_v$ ): 0.07 Standard, 0.24 optional \*\*  
 Inlet and Outlet: 1/4" NPT female

## MATERIALS OF CONSTRUCTION

Body: brass  
 Poppet: 316L stainless steel  
 Poppet Spring: Inconel®  
 Seat: Tefzel  
 Diaphragm: stainless steel  
 Diaphragm Gasket: Teflon®  
 Inlet Filter: stainless steel  
 Bonnet: chrome plated aluminum  
 Gauges: brass

## HOW TO ORDER\*\*\*

Model Number	Del. Press. Range psig	Del. Press. Gauge psig	Inlet Press. Gauge psig
3101-25-CGA*	5-25	0-60	0-4000
3101-50-CGA*	5-50	0-100	0-4000
3101-100-CGA*	10-100	0-200	0-4000
3101-250-CGA*	10-250	0-400	0-4000
3101-500-CGA*	100-500	0-1000	0-4000
3102-25-CGA*	5-25	0-60	0-1000
3102-50-CGA*	5-50	0-100	0-1000
3102-100-CGA*	10-100	0-200	0-1000
3102-250-CGA*	10-250	0-400	0-1000
3103-25-CGA*	5-25	0-60	0-400
3103-50-CGA*	5-50	0-100	0-400
3103-100-CGA*	10-100	0-200	0-400
3104-25-CGA	5-25	0-60	none
3104-50-CGA*	5-50	0-100	none
3104-100-CGA*	10-100	0-200	none

\*Specify CGA Connection Number when ordering.

\*\* Add "HF" to basic model number (i.e., 3101HF -25-CGA).

\*\*\*For panel mounting bonnet add "PM" to base number (i.e., 3101PM-25-CGA).

## OUTLET OPTIONS

	P/N Suffix
No Outlet Valve	NV
1/4" Compression Fitting	T4F
1/8" Compression Fitting	T2F
1/4" NPT Male	P4M
1/4" Hose Barb	4HB



EZ3000 Bracket see page 85.

# BRASS HIGH PURITY 2-STAGE REGULATOR Series 3200

## DESCRIPTION

The Series 3200 two stage regulators are designed and constructed for both high purity and general purpose applications. While compact in design these regulators provide outstanding performance, comparable to most larger diaphragm competitive models. They are ideally suited for use with gases and gas mixtures having a full cylinder pressure of 1000 psig or more. The construction is rugged enough for the plant, yet versatile enough for the laboratory.

## FEATURES

- High purity diffusion resistant, metal diaphragm construction on both stages.
- Diffusion resistant, brass diaphragm packless control valve installed on outlet as standard.
- Designed to pass an inboard helium leak-rate test of  $1 \times 10^{-9}$  cc per sec.
- All parts ultrasonically cleaned prior to assembly.
- Optional interstage safety relief valve available.

## APPLICATIONS

The 3200 Series regulators are ideal for critical pressure reduction applications, where the precise control of pressure or flow is required. They are an excellent choice for use with high purity carrier gases or gas mixtures used with gas chromatographs and other instrumentation. Once you experience the improved control of gas to your gas chromatograph or other system, you will want to upgrade all your other regulators.

## SPECIFICATIONS

Max. Inlet Pressure: 3000 psig  
 Operating Temp. Range: -40° to +185°F  
 Flow Coefficient( $C_v$ ): 0.07 Standard, 0.24 optional\*\*  
 Inlet and Outlet: 1/4" NPT female  
 Delivery Pressure Rise: 0.02 psig max. per 100 psi inlet pressure decay.

## HOW TO ORDER\*\*\*

Model Number	Del. Press. Range psig	Del. Press. Gauge psig	Inlet Press. Gauge psig
3201-10-CGA*	5-10	0-15	0-4000
3201-25-CGA*	5-25	0-30	0-4000
3201-50-CGA*	5-50	0-100	0-4000
3201-100-CGA*	10-100	0-200	0-4000
3201-250-CGA*	10-250	0-400	0-4000
3201-500-CGA*	100-500	0-1000	0-4000*Specify

Connection Number when ordering.

\*\*Add "HF" to basic model number (i.e. 3201 HF-25-CGA).

\*\*\*For panel mounting bonnet add "PM" to base number (i.e., 3201PM-50-CGA).



## MATERIALS OF CONSTRUCTION

Body: brass  
 Poppet: 316L stainless steel  
 Poppet Spring: Inconel®  
 Seat: 1st stage - Tefzel  
 2nd stage - Tefzel  
 Diaphragm: stainless steel  
 Diaphragm Gasket: Teflon®  
 Inlet Filter: stainless steel  
 Bonnet: chrome plated aluminum  
 Gauges: brass



EZ3000 Bracket  
 see page 85.

## OUTLET OPTIONS

	P/N Suffix
No Outlet Valve	NV
1/4" Compression Fitting	T4F
1/8" Compression Fitting	T2F
1/4" NPT Male	P4M
1/4" Hose Barb	4HB

# STAINLESS STEEL HIGH PURITY 1-STAGE REGULATOR Series 3400

## DESCRIPTION

The Series 3400 single stage regulators are designed and constructed for both high purity and general purpose applications. They provide outstanding performance, yet they are rugged and versatile enough for the laboratory or plant.

## FEATURES

- Low internal volume - less than 6 cc.
- High purity diffusion resistant, metal diaphragm construction.
- Diffusion resistant, stainless steel diaphragm packless control valve installed on outlet as standard.
- Designed to pass an inboard helium leak-rate test of  $1 \times 10^{-9}$  cc per sec.
- All parts ultrasonically cleaned prior to assembly.

## APPLICATIONS

The 3400 Series regulators are ideal for use with many corrosive gases, such as ammonia, hydrogen sulfide, and sulfur dioxide. They are also very useful for controlling the pressure of gas mixtures containing reactive gas components and low levels of the corrosive halogen gases, like chlorine.

## SPECIFICATIONS

Max. Inlet Pressure: 3000 psig  
 Operating Temp. Range: -40° to +185°F.  
 Flow Coefficient ( $C_v$ ): 0.07 standard, 0.24 optional\*\*  
 Inlet and Outlet: 1/4" NPT female



## MATERIALS OF CONSTRUCTION

Body: 316L stainless steel  
 Poppet: 316L stainless steel  
 Poppet Spring: Inconel®  
 Seat: Tefzel  
 Diaphragm: stainless steel  
 Diaphragm Gasket: Teflon®  
 Inlet Filter: stainless steel  
 Bonnet: chrome plated aluminum  
 Gauges: 316 stainless steel

## HOW TO ORDER\*\*\*

Model Number	Del. Press. Range psig	Del. Press. Gauge psig	Inlet Press. Gauge psig
3401-25-CGA*	5-25	0-60	0-3000
3401-50-CGA*	5-50	0-100	0-3000
3401-100-CGA*	10-100	0-200	0-3000
3401-250-CGA*	25-250	0-400	0-3000
3401-500-CGA*	100-500	0-1000	0-3000
3402-25-CGA*	5-25	0-60	0-1000
3402-50-CGA*	5-50	0-100	0-1000
3402-100-CGA*	10-100	0-200	0-1000
3403-25-CGA*	5-25	0-60	0-400
3403-50-CGA*	5-50	0-100	0-400
3404-25-CGA*	5-25	0-60	none
3404-50-CGA*	5-50	0-100	none

\*Specify CGA Connection Number when ordering.

\*\* Add "HF" to basic model number (i.e. 3401HF -25-CGA).

\*\*\*For panel mounting bonnet add "PM" to base number (i.e., 3401PM-50-CGA).

## OUTLET OPTIONS

	P/N Suffix
No Outlet Valve	NV
1/4" Compression Fitting	T4F
1/8" Compression Fitting	T2F
1/4" NPT Male	P4M
1/4" Hose Barb	4HB

**Warning:** A Purge assembly (see pages 80 and 81) is strongly suggested when using the above regulators with any corrosive gas.

# STAINLESS STEEL HIGH PURITY 2-STAGE REGULATOR Series 3500

## DESCRIPTION

The Series 3500 two stage regulators are designed and constructed for both high purity and general purpose applications. While compact in design these regulators provide outstanding performance, comparable to most larger diaphragm competitive models. They are an excellent choice for use with ultra high purity gases or gas mixtures having a full cylinder pressure of 1000 psig or more. They are rugged and versatile enough for the laboratory or plant.

## FEATURES

- High purity diffusion resistant, metal diaphragm construction on both stages.
- Diffusion resistant, stainless steel diaphragm packless control valve installed on outlet as standard.
- Designed to pass an inboard helium leak-rate test of  $1 \times 10^{-9}$  cc per sec.
- All parts ultrasonically cleaned prior to assembly.
- Optional interstage safety relief valve available.

## APPLICATIONS

The 3500 Series regulators are ideal for critical pressure reduction applications, where the precise control of pressure or flow is required. They are also very useful for controlling the pressure of gas mixtures containing corrosive gases, such as ammonia, hydrogen sulfide, sulfur dioxide, and low levels of the corrosive halogen gases, like chlorine.

## SPECIFICATIONS

Max. Inlet Pressure: 3000 psig  
 Operating Temp. Range: -40° to +185° F.  
 Flow Coefficient ( $C_v$ ): 0.07 standard, 0.24 optional\*\*  
 Inlet and Outlet: 1/4" NPT female  
 Delivery Pressure Rise: 0.02 psig max. per 100 psi inlet pressure decay.

## HOW TO ORDER\*\*\*

Model Number	Del. Press. Range psig	Del. Press. Gauge psig	Inlet Press. Gauge psig
3501-10-CGA*	5-10	0-15	0-3000
3501-25-CGA*	5-25	0-30	0-3000
3501-50-CGA*	5-50	0-100	0-3000
3501-100-CGA*	10-100	0-200	0-3000
3501-250-CGA*	25-250	0-400	0-3000
3501-500-CGA*	100-500	0-1000	0-3000

\*Specify CGA Connection Number when ordering.

\*\*Add "HF" to basic model number (i.e. 3501 HF-25-CGA).

\*\*\*For panel mounting bonnet add "PM" to base number (i.e., 3501PM-50-CGA).



## MATERIALS OF CONSTRUCTION

Body: 316L stainless steel  
 Poppet: 316L stainless steel  
 Poppet Spring: Inconel®  
 Seat: 1st stage - Tefzel  
       2nd stage - Tefzel  
 Diaphragm: stainless steel  
 Diaphragm Gasket: Teflon®  
 Inlet Filter: stainless steel  
 Bonnet: chrome plated aluminum  
 Gauges: 316 stainless steel

## OUTLET OPTIONS

	P/N Suffix
No Outlet Valve	NV
1/4" Compression Fitting	T4F
1/8" Compression Fitting	T2F
1/4" NPT Male	P4M
1/4" Hose Barb	4HB

**Warning:** A Purge assembly (see pages 80 and 81) is strongly suggested when using the above regulators with any corrosive gas.

# ECONOMICAL, CORROSIVE GAS, HIGH PURITY 1-STAGE REGULATOR

## Series 3450

### DESCRIPTION

The Series 3450 single stage regulators are specifically designed and constructed for use with difficult to handle gases, like chlorine and hydrogen chloride. The monel<sup>®</sup> diaphragm, inlet filter, poppet and nozzle assembly installed in a 316L stainless steel body create an economical high purity corrosive gas regulator for most applications.

### FEATURES

- Monel<sup>®</sup> internal parts for added corrosion resistance.
- High purity diffusion resistant, metal diaphragm construction.
- Diffusion resistant, diaphragm packless control valve installed on outlet as standard.
- Designed to pass an inboard helium leak-rate test of  $1 \times 10^{-9}$  cc per sec.
- All parts ultrasonically cleaned prior to assembly.

### APPLICATIONS

The 3450 Series regulators are ideal for use with many corrosive gases, such as chlorine, hydrogen chloride, boron trichloride, and boron trifluoride. They are also useful for controlling the pressure of gas mixtures containing these corrosive gas components, particularly at higher concentration levels.

### SPECIFICATIONS

Max. Inlet Pressure: 3000 psig  
 Operating Temp. Range: -40° to +185°F.  
 Flow Coefficient(C<sub>v</sub>): 0.07  
 Inlet and Outlet: 1/4" NPT Female



### MATERIALS OF CONSTRUCTION

Body: 316L stainless steel  
 Poppet: monel<sup>®</sup>  
 Poppet Spring: Inconel<sup>®</sup>  
 Seat: Tefzel  
 Diaphragm: monel<sup>®</sup>  
 Diaphragm Gasket: Teflon<sup>®</sup>  
 Inlet Filter: monel<sup>®</sup>  
 Bonnet: chrome plated aluminum  
 Gauges: 316 stainless steel  
 Outlet Valve: 316 stainless steel  
 Outlet Connections: 316 stainless steel

### HOW TO ORDER\*\*\*

Model Number+	Del. Press. Range psig	Del. Press. Gauge psig	Inlet Press. Gauge psig
3451-25-CGA*	5-25	0-60	0-3000
3451-50-CGA*	5-50	0-100	0-3000
3451-100-CGA*	10-100	0-200	0-3000
3452-25-CGA*	5-25	0-60	0-1000
3452-50-CGA*	5-50	0-100	0-1000
3452-100-CGA*	10-100	0-200	0-1000
3453-25-CGA*	5-25	0-60	0-400
3453-50-CGA*	5-50	0-100	0-400
3454-25-CGA*	5-25	0-60	none
3454-50-CGA*	5-50	0-100	none

\*Specify CGA Connection Number when ordering

\*\*\*For panel mounting bonnet add "PM" to base number (i.e., 3451PM-50-CGA).

### OUTLET OPTIONS

	P/N Suffix
No Outlet Valve	NV
1/4" Compression Fitting	T4F
1/8" Compression Fitting	T2F
1/4" NPT Male	P4M
1/4" Hose Barb	4HB

**Warning:** A Purge assembly (see pages 80 and 81) is strongly suggested when using the above regulators with any corrosive gas.

# **ECONOMICAL, CORROSIVE GAS, HIGH PURITY 2-STAGE REGULATOR**

## **Series 3550**

### **DESCRIPTION**

The Series 3550 two stage regulators are designed and constructed for use with reactive and corrosive gases and gas mixtures. While compact in design these regulators provide outstanding performance, comparable to most larger diaphragm competitive models. The monel® diaphragms, inlet filter, poppets and nozzle assemblies installed in a 316L stainless steel body create an economical, high purity, corrosive gas regulator.

### **FEATURES**

- Monel® internal parts for added corrosion resistance.
- High purity diffusion resistant, metal diaphragm construction on both stages.
- Diffusion resistant, stainless steel diaphragm packless control valve installed on outlet as standard.
- Designed to pass an inboard helium leak-rate test of  $1 \times 10^{-9}$  cc per sec.
- All parts ultrasonically cleaned prior to assembly.

### **APPLICATIONS**

The 3550 Series regulators are ideal for critical pressure reduction applications involving higher pressure reactive and/or corrosive gases, where the precise control of pressure or flow is required. They are an excellent choice for use with gas mixtures of such components having a full cylinder pressure of 1000 psig or more.

### **SPECIFICATIONS**

Max. Inlet Pressure: 3000 psig  
 Operating Temp. Range: -40° to +185°F.  
 Flow Coefficient( $C_v$ ): 0.07  
 Inlet and Outlet: 1/4" NPT female  
 Delivery Pressure Rise: 0.02 psig max. per 100 psi inlet pressure decay.



### **MATERIALS OF CONSTRUCTION**

Body: 316L stainless steel  
 Poppets: monel®  
 Poppet Springs: Inconel®  
 Seats: 1st stage - Tefzel  
           2nd stage - Tefzel  
 Diaphragms: monel®  
 Diaphragm Gaskets: Teflon®  
 Inlet Filter: monel®  
 Bonnet: chrome plated aluminum  
 Gauges: stainless steel  
 Outlet Valve: 316 stainless steel  
 Outlet Connections: 316 stainless steel

### **HOW TO ORDER\*\*\***

<b>Model Number</b>	<b>Del. Press. Range psig</b>	<b>Del. Press. Gauge psig</b>	<b>Inlet Press. Gauge psig</b>
3551-25-CGA*	5-25	0-30	0-3000
3551-50-CGA*	5-50	0-100	0-3000
3551-100-CGA*	10-100	0-200	0-3000

\*Specify CGA Connection Number when ordering.

\*\*\*For panel mounting bonnet add "PM" to base number (i.e., 3551PM-50-CGA).

### **OUTLET OPTIONS**

	<b>P/N Suffix</b>
No Outlet Valve	NV
1/4" Compression Fitting	T4F
1/8" Compression Fitting	T2F
1/4" NPT Male	P4M
1/4" Hose Barb	4HB

**Warning:** A Purge assembly (see pages 80 and 81) is strongly suggested when using the above regulators with any corrosive gas.

# CORROSIVE GAS, HIGH PURITY 1-STAGE REGULATOR Series 3460

## DESCRIPTION

The Series 3460 single stage regulators are specifically designed and constructed for use with difficult to handle gases, like chlorine and hydrogen chloride. The monel<sup>®</sup> diaphragm, inlet filter, poppet and nozzle assembly installed in a monel<sup>®</sup> body with a 316 stainless steel bonnet create an high purity corrosive gas regulator for most difficult environments.

## FEATURES

- Monel<sup>®</sup> internal parts and body for added corrosion resistance.
- High purity diffusion resistant, metal diaphragm construction.
- Diffusion resistant, aluminum-silicon-bronze diaphragm packless control valve installed on outlet.
- Designed to pass an inboard helium leak-rate test of  $1 \times 10^{-9}$  cc per sec.
- All parts ultrasonically cleaned prior to assembly.

## APPLICATIONS

The 3460 Series regulators are ideal for use with many corrosive gases, such as chlorine, hydrogen chloride, boron trichloride, and boron trifluoride under demanding environmental conditions. They are also useful for controlling the pressure of gas mixtures containing these corrosive gas components, particularly at higher concentration levels.

## SPECIFICATIONS

Max. Inlet Pressure: 3000 psig  
 Operating Temp. Range: -40° to +185°F  
 Flow Coefficient(C<sub>v</sub>): 0.07  
 Inlet and Outlet: 1/4" NPT female

## HOW TO ORDER\*\*\*

Model Number	Del. Press. Range psig	Del. Press. Gauge psig	Inlet Press. Gauge psig
3461-25-CGA*	5-25	0-60	0-3000
3461-50-CGA*	5-50	0-100	0-3000
3461-100-CGA*	10-100	0-200	0-3000
3462-25-CGA*	5-25	0-60	0-1000
3462-50-CGA*	5-50	0-100	0-1000
3462-100-CGA*	10-100	0-200	0-1000
3463-25-CGA*	5-25	0-60	0-400
3463-50-CGA*	5-50	0-100	0-400
3464-25-CGA*	5-25	0-60	none
3464-50-CGA*	5-50	0-100	none

\*Specify CGA Connection Number when ordering.

\*\*\*For panel mounting bonnet add "PM" to base number (i.e., 3461PM-50-CGA).



## MATERIALS OF CONSTRUCTION

Body: monel<sup>®</sup>  
 Poppet: monel<sup>®</sup>  
 Poppet Spring: Inconel<sup>®</sup>  
 Seat: Tefzel  
 Diaphragm: monel<sup>®</sup>  
 Diaphragm Gasket: Teflon<sup>®</sup>  
 Inlet Filter: monel<sup>®</sup>  
 Bonnet: stainless steel  
 Gauges: monel<sup>®</sup>

## OUTLET OPTIONS

	P/N Suffix
No Outlet Valve	NV
1/4" Compression Fitting	T4F

**Warning:** A Purge assembly (see pages 80 and 81) is strongly suggested when using the above regulators with any corrosive gas.

# **CORROSIVE GAS, HIGH PURITY 2-STAGE REGULATOR**

## **Series 3560**

### **DESCRIPTION**

The Series 3560 two-stage regulators are designed and constructed for use with reactive and corrosive gases and gas mixtures. While compact in design these regulators provide outstanding performance, comparable to most larger diaphragm competitive models. The monel® diaphragms, inlet filter, poppets and nozzle assemblies installed in a monel® body stainless steel bonnet create a high purity, corrosive gas regulator suitable for most difficult environments.

### **FEATURES**

- Monel® internal parts for added corrosion resistance.
- High purity diffusion resistant, metal diaphragm construction on both stages.
- Diffusion resistant, aluminum-silicon-bronze diaphragm packless control valve installed on outlet as standard.
- Designed to pass an inboard helium leak-rate test of  $1 \times 10^{-9}$  cc per sec.
- All parts ultrasonically cleaned prior to assembly.

### **APPLICATIONS**

The 3560 Series regulators are ideal for critical pressure reduction applications involving higher pressure reactive and/or corrosive gases, where the precise control of pressure or flow is required. They are an excellent choice for use with gas mixtures of such components having a full cylinder pressure of 1000 psig or more.

### **SPECIFICATIONS**

Max. Inlet Pressure: 3000 psig  
 Operating Temp. Range: -40° to +185°F.  
 Flow Coefficient(C<sub>v</sub>): 0.07  
 Inlet and Outlet: 1/4" NPT female  
 Delivery Pressure Rise: 0.02 psig max. per 100 psi inlet pressure decay.

### **HOW TO ORDER\*\*\***

<b>Model Number</b>	<b>Del. Press. Range psig</b>	<b>Del. Press. Gauge psig</b>	<b>Inlet Press. Gauge psig</b>
3561-25-CGA*	5-25	0-60	0-3000
3561-50-CGA*	5-50	0-100	0-3000
3561-100-CGA*	10-100	0-200	0-3000

\*Specify CGA Connection Number when ordering.

\*\*\*For panel mounting bonnet add "PM" to base number (i.e., 3561PM-50-CGA).



### **MATERIALS OF CONSTRUCTION**

Body: monel®  
 Poppets: monel®  
 Poppet Springs: Inconel®  
 Seats: 1st stage - Tefzel  
           2nd stage - Teflon®  
 Diaphragms: monel®  
 Diaphragm Gaskets: Teflon®  
 Inlet Filter: monel®  
 Bonnet: stainless steel  
 Gauges: monel®  
 Outlet Valve - aluminum-silicon-bronze

### **OUTLET OPTIONS**

	<b>P/N Suffix</b>
No Outlet Valve	NV
1/4" Compression Fitting	T4F

**Warning:** A Purge assembly (see pages 80 and 81) is strongly suggested when using the above regulators with any corrosive gas.

# BRASS HIGH PURITY LINE REGULATOR Series 3101L

## DESCRIPTION

The 3101L Series line regulators are designed to suit a large variety of applications. The high purity design makes them ideal for line drop regulators in instrumentation labs, with the 0.24 C<sub>v</sub> orifice they are capable of very high flow rates.

## FEATURES

- Capable of large flows with only a small pressure drop.
- High purity diffusion resistant, metal diaphragm construction.
- Diffusion resistant, brass diaphragm packless control valve installed on the outlet as standard.
- Designed to pass an inboard helium leak-rate test of 1x10<sup>-9</sup> cc per sec.
- All parts ultrasonically cleaned prior to assembly.

## APPLICATIONS

The 3101L Series is an excellent choice for gas flow applications with low inlet pressures and low differential pressure between regulator inlet and outlet.

## SPECIFICATIONS

Max. Inlet Pressure: 3000 psig  
 Operating Temp. Range: -40° to +185°F.  
 Flow Coefficient(C<sub>v</sub>): 0.07 standard, 0.24 C<sub>v</sub> optional\*\*  
 Inlet and Outlet: 1/4" NPT female

## MATERIALS OF CONSTRUCTION

Body: brass  
 Poppet: stainless steel  
 Poppet Spring: Inconel®  
 Diaphragm: stainless steel  
 Seat: Tefzel  
 Diaphragm gasket: Teflon®  
 Inlet Filter: stainless steel  
 Bonnet: chrome plated aluminum  
 Gauge: brass



EZ3000 Bracket  
 see page 85.

## HOW TO ORDER\*\*\*

Model Number	Del. Press. Range psig	Del. Press. Gauge psig
3101L-25	5-25	0-60
3101L-50	5-50	0-100
3101L-100	10-100	0-200
3101L-250	20-250	0-400

\*\* Add "HF" to basic model number (i.e. 3101LHF-25).  
 \*\*\*For panel mounting bonnet add "PM" to base number (i.e., 3101LPM-50).

## OUTLET OPTIONS

	P/N Suffix
No Outlet Valve	NV
1/4" Compression Fitting	T4F
1/8" Compression Fitting	T2F
1/4" NPT Male	P4M

# STAINLESS STEEL HIGH PURITY LINE REGULATOR Series 3401L

## DESCRIPTION

The 3401L Series line regulators are designed to suit a large variety of applications. The high purity design makes them ideal for line drop regulators in instrumentation labs, with the 0.24 C<sub>v</sub> orifice they are capable of very high flow rates.

## FEATURES

- Capable of large flows with only a small pressure drop.
- High purity diffusion resistant, metal diaphragm construction.
- Diffusion resistant, stainless steel diaphragm packless control valve installed on the outlet as standard.
- Designed to pass an inboard helium leak-rate test of 1x10<sup>-9</sup> cc per sec.
- All parts ultrasonically cleaned prior to assembly.

## APPLICATIONS

The 3401L Series is an excellent choice for gas flow applications with low inlet pressures and low differential pressure between inlet and outlet. The high inlet pressure rating makes also very suitable as a sensitive cylinder regulator for many low pressure corrosive gases when fitted with the proper CGA cylinder valve outlet connection.

## SPECIFICATIONS

Max. Inlet Pressure: 3000 psig  
 Operating Temp. Range: -40° to +185°F.  
 Flow Coefficient(C<sub>v</sub>): 0.07 standard, 0.24 C<sub>v</sub> optional \*\*  
 Inlet and Outlet: 1/4" NPT female



## MATERIALS OF CONSTRUCTION

Body: 316L stainless steel  
 Poppet: 316L stainless steel  
 Poppet Spring: Inconel®  
 Diaphragm: stainless steel  
 Seat: Tefzel  
 Diaphragm gasket: Teflon®  
 Inlet Filter: stainless steel  
 Bonnet: chrome plated aluminum  
 Gauge: stainless steel

## HOW TO ORDER\*\*\*

Model Number+	Del. Press. Range psig	Del. Press. Gauge psig
3401L-25	5-25	0-60
3401L-50	5-50	0-100
3401L-100	10-100	0-200
3401-250	20-250	0-400

\*\*Add "HF" to basic model number (i.e. 3401LHF-25).

\*\*\*For panel mounting bonnet add "PM" to base number (i.e., 3401LPM-50).

## OUTLET OPTIONS

	P/N Suffix
No Outlet Valve	NV
1/4" Compression Fitting	T4F
1/8" Compression Fitting	T2F
1/4" NPT Male	P4M

# ECONOMICAL CORROSIVE GAS HIGH PURITY LINE REGULATOR Series 3451L

## DESCRIPTION

The 3451L Series line regulators are designed to suit a large variety of applications. With a 0.24 C<sub>v</sub> orifice these regulators can handle flows with a high minimum pressure drop. The installation of a monel® diaphragm, poppet and nozzle assembly into a stainless steel body creates an economical, high purity line regulator for corrosive gas service.

## FEATURES

- Capable of large flows with only a small pressure drop.
- Monel® internal construction for increased corrosion resistance.
- High purity diffusion resistant, metal diaphragm construction.
- Diffusion resistant, stainless steel diaphragm packless control valve installed on the outlet as standard.
- Designed to pass an inboard helium leak-rate test of 1x10<sup>-9</sup> cc per sec.
- All parts ultrasonically cleaned prior to assembly.

## APPLICATIONS

The 3451L Series is an excellent choice for corrosive gas flow applications with low inlet pressures and low differential pressure between regulator inlet and outlet.

## SPECIFICATIONS

Max. Inlet Pressure: 3000 psig  
 Operating Temp. Range: -40° to +185°F.  
 Flow Coefficient(C<sub>v</sub>): 0.07 standard, 0.24C<sub>v</sub> optional\*\*  
 Inlet and Outlet: 1/4" NPT female



## MATERIALS OF CONSTRUCTION

Body: 316L Stainless Steel  
 Poppet: monel®  
 Poppet Spring: inconel®  
 Diaphragm: monel®  
 Seat: Tefzel  
 Diaphragm gasket: Teflon®  
 Inlet Filter: stainless steel  
 Bonnet: chrome plated aluminum  
 Gauge: stainless steel

## HOW TO ORDER\*\*\*

Model Number	Del. Press. Range psig	Del. Press. Gauge psig
3451L-25	5-25	0-60
3451L-50	5-50	0-100
3451L-100	10-100	0-200

\*\*Add "HF" to basic model number (i.e. 3451LHF-25).

\*\*\*For panel mounting bonnet add "PM" to base number (i.e., 3451LPM-50).

## OUTLET OPTIONS

	P/N Suffix
No Outlet Valve	NV
1/4" Compression Fitting	T4F
1/8" Compression Fitting	T2F
1/4" NPT Male	P4M

# **CORROSIVE GAS HIGH PURITY LINE REGULATOR Series 3461L**

## **DESCRIPTION**

The 3461L Series line regulators are designed to suit a large variety of applications. These regulators can handle flows up to 200 liters per minute of nitrogen with only 5 psig pressure drop. The large diaphragm permits the regulator to handle varying flow rates with minimal effect on outlet pressure set point. The installation of a monel® diaphragm, poppet and nozzle assembly in a monel® body fitted with a stainless steel bonnet create a high purity line regulator for corrosive gas service for many difficult environments.

## **FEATURES**

- Capable of large flows with only a small pressure drop.
- Monel® body, gauges and internal construction for increased corrosion resistance.
- High purity diffusion resistant, metal diaphragm construction.
- Diffusion resistant, aluminum-silicon-bronze diaphragm packless control valve installed on the outlet.
- Designed to pass an inboard helium leak-rate test of  $1 \times 10^{-9}$  cc per sec.
- All parts ultrasonically cleaned prior to assembly.

## **APPLICATIONS**

The 3461L Series is an excellent choice for corrosive gas flow applications with low inlet pressures and low differential pressure between regulator inlet and outlet; they are the unit of choice in tough environmental conditions.

## **SPECIFICATIONS**

Max. Inlet Pressure: 3000 psig  
 Operating Temp. Range: -40° to +185°F.  
 Flow Coefficient ( $C_v$ ): 0.07 standard, 0.24  $C_v$  optional\*\*  
 Inlet and Outlet: 1/4" NPT female

## **HOW TO ORDER\*\*\***

<b>Model Number</b>	<b>Del. Press. Range psig</b>	<b>Del. Press. Gauge psig</b>
3461L-25	5-25	0-60
3461L-50	5-50	0-100
3461L-100	10-100	0-200

\*\* Add "HF" to basic model number (i.e. 3461LHF-25).

\*\*\*For panel mounting bonnet add "PM" to base number (i.e., 3461LPM-50).



## **MATERIALS OF CONSTRUCTION**

Body: monel®  
 Poppet: monel®  
 Poppet Spring: inconel®  
 Diaphragm: monel®  
 Seat: Tefzel  
 Diaphragm gasket: Teflon®  
 Inlet Filter: monel®  
 Bonnet: stainless steel  
 Gauge: monel®

## **OUTLET OPTIONS**

	<b>P/N Suffix</b>
No Outlet Valve	NV
1/4" Compression Fitting	T4F

# HIGH FLOW – HIGH PURITY REGULATOR

## Series 3830

### DESCRIPTION

The 3830 series regulators are designed for high flow applications involving high purity or corrosive gases. The series features a large main valve with a Cv of 1.0. In the high pressure version the main valve is balanced to minimize the effect of inlet pressure fluctuations on outlet pressure. The low pressure inlet line regulator version uses an unbalanced main valve for reliable shutoff.

### FEATURES

- Capable of high flows with only a small pressure drop.
- High purity metal diaphragm construction.
- All parts ultrasonically cleaned prior to assembly.
- Designed to pass an inboard leak-rate test of  $2 \times 10^{-8}$  cc/sec.

### APPLICATIONS

The 3830 series regulators are ideal for high flow systems of high purity or corrosive gas whether used as a high pressure regulator or a line regulator with inlet pressure less than 500 psig.

### SPECIFICATIONS

	3830	3830L
Max. Inlet Pressure:	3000 psig	500 psig
Operating Temp. Range:	-40°F to +165°	-40°F to +165°
Flow Coefficient(Cv):	1.0	1.0
Inlet and Outlet:	1/2" NPT	1/2" NPT



3831

### MATERIALS OF CONSTRUCTION

	3831	3831L	3832	3832L
Body:	brass	brass	316 SS	316 SS
Bonnet:	nickel plated brass	nickel plated brass	nickel plated brass	nickel plated brass
Diaphragm:	316 SS	316 SS	316 SS	316 SS
Seat:	CTFE	Teflon	CTFE	Teflon
Seal:	Teflon	Teflon	Teflon	Teflon
Main valve:	316 SS	316 SS	316 SS	316 SS
Gauges:	brass	brass	SS	SS

### HOW TO ORDER\*\*\*

Model Number	Del. Press. Range psig	Del. Press. Gauge psig	Inlet Press. Gauge psig
3831-25	0-25	0-60	0-4000
3831-50	0-50	0-100	0-4000
3831-100	0-100	0-200	0-4000
3831-150	0-150	0-200	0-4000
3831-200	0-200	0-400	0-4000
3831L-25	0-25	0-60	none
3831L-50	0-50	0-100	none
3831L-100	0-100	0-200	none
3831L-150	0-150	0-200	none
3831L-200	0-200	0-400	none
3832-25	0-25	0-60	0-3000
3832-50	0-50	0-100	0-3000
3832-100	0-100	0-200	0-3000
3832-150	0-150	0-200	0-3000
3832-200	0-200	0-400	0-3000
3832L-25	0-25	0-60	none
3832L-50	0-50	0-100	none
3832L-100	0-100	0-200	none
3832L-150	0-150	0-200	none
3832L-200	0-200	0-400	none

\*\*\*For panel mounting bonnet add "PM" to base number (i.e., 3831LPM-50).



3831L

## **ECONOMICAL, CORROSIVE GAS, 1-STAGE REGULATOR**

### **Series 3470**

#### **DESCRIPTION**

The Series 3470 single stage regulators are specifically designed and constructed for use with difficult to handle gases, such as chlorine and hydrogen chloride. The large monel nozzle and Kel-F seat combined with the tied diaphragm assembly greatly reduces the possibility of failure due to creep so common in other corrosive gas regulators. A Teflon-lining on the stainless steel diaphragm forms a protective coating to extend regulator life. The electroless nickel-plated brass body is a major contributor to the economical nature of this regulator while providing corrosion protection.

#### **FEATURES**

- Four built-in Kel-F seats provide convenient maintenance and long regulator life.
- Large Teflon-lined 302 stainless steel diaphragm.
- Monel valve with Teflon packing installed on outlet.
- Captured vent bonnet provides for safe venting in the event of a diaphragm failure.

#### **APPLICATIONS**

The 3470 Series regulators are ideal for use with many corrosive gases, such as chlorine, hydrogen chloride, boron trichloride, and boron trifluoride. They are also useful for controlling the pressure of high concentration gas mixtures containing these corrosive gas components.



#### **MATERIALS OF CONSTRUCTION**

Body: Electroless nickel-plated brass  
Nozzle: monel  
Seat: Kel-F  
Diaphragm: Teflon-lined 302 stainless steel  
Inlet Filter: Electroless nickel-plated sintered bronze  
Seals: Teflon

#### **SPECIFICATIONS**

Max. Inlet Pressure - 3000 psig  
Operating Temp. Range - 20° to +160°F  
Body Inlet and Outlet - 1/4" NPT female  
Valve outlet - 1/4" NPT male

#### **HOW TO ORDER**

<b>Model Number*</b>	<b>Del. Press. Range psig</b>	<b>Del. Press. Gauge psig</b>	<b>Inlet Press. Gauge psig</b>
3470-80-CGA*	5-80	0-100	0-3000
3470-160-CGA*	10-160	0-300	0-3000
3471-80-CGA*	5-80	0-100	0-1000
3471-160-CGA*	10-160	0-300	0-1000
3472-80-CGA*	5-80	0-100	0-300
3473-80-CGA	5-80	0-100	None

\*Specify CGA Connection Number when ordering.

**Warning:** A Purge assembly (see pages 80 and 81) is strongly suggested when using the above regulators with any corrosive gas.

## HIGH PURITY LOW DELIVERY PRESSURE REGULATORS Series 3700HP

### DESCRIPTION

These regulators were designed to meet the needs of applications requiring reliable low-pressure control while maintaining gas purity. They are available in single and two stage versions to meet most non-corrosive gas applications. The low pressure stage has a large sensitive aluminum-faced neoprene diaphragm to provide delivery pressures as low as 2" of water.



### Single Stage Line Regulators for Non-corrosive Gases

#### MATERIALS OF CONSTRUCTION

Body & Bonnet: Zinc  
 Seat: Nitrile  
 Diaphragm: Aluminum-faced natural rubber  
 Internal parts: Steel, brass, and zinc

The Series 3700HP regulators are available in two delivery pressure ranges; 2-35" of water, and 0.5-5 psig. As a line regulator they have a maximum inlet pressure rating of 250 psig. Inlet and outlet connections are 1/4" NPT female. The Series 3700HP has an aluminum faced natural rubber diaphragm to provide a diffusion resistant metal barrier for high purity gas applications. If you do not desire the outlet valve add suffix "NV" to the part number.

#### FEATURES

- Extremely low delivery pressures
- Knob for adjusting delivery pressure
- Aluminum faced diaphragm for high purity applications
- Maximum inlet pressure 250 psig
- Diaphragm packless valve on outlet is standard

#### HOW TO ORDER

Model Number	Del. Press. Range psig	Del. Press. Gauge psig	Inlet Press. Gauge psig
3701HP	2-25" water	0-30" water	none
3702HP	0.5-5 psig	0-10 psig	none

### Two-stage High Purity Regulators for Low Pressure Delivery

When source gas pressures exceed 250 psig, this hybrid regulator created by coupling a Series 3700HP regulator with a Series 3101 single stage regulator is an ideal choice for such higher pressure applications



#### MATERIALS OF CONSTRUCTION

First Stage See model 3101 on page 4  
 2nd Stage See above

#### HOW TO ORDER

Model Number	Del. Press. Range psig	Del. Press. Gauge psig	Inlet Press. Gauge psig
3101HY3701-CGA*	2-25" water	0-30" water	0-4000 psig
3101HY3702-CGA*	0.5-5 psig	0-10 psig	0-4000 psig

\*Specify CGA connection when ordering. If you do not desire the standard outlet valve add the suffix "NV" to the part number.

# GENERAL PURPOSE LOW DELIVERY PRESSURE REGULATORS

## Series 3700

### DESCRIPTION

These regulators were designed to meet the needs of applications requiring reliable low-pressure control of non-high purity gases. They are available in single and two stage versions to meet most non-corrosive gas applications. The low pressure stage has a large sensitive neoprene diaphragm to provide delivery pressures as low as 2" of water.



## Single Stage Line Regulators for Non-corrosive Gases

### MATERIALS OF CONSTRUCTION

Body & Bonnet: Zinc  
 Seat: Nitrile  
 Diaphragm: Natural rubber  
 Internal parts: Steel, brass, zinc

The Series 3700 regulators are available in two delivery pressure ranges; 2-35" of water, and 0.5-5 psig. As a line regulator they have a maximum inlet pressure rating of 250 psig. The inlet and outlet connections of the regulator are 1/4" NPT female, but with the standard needle valve installed the outlet connection is 1/4" NPT male. If you do not desire the outlet valve add suffix "NV" to the part number.

### FEATURES

- Extremely low delivery pressures
- Knob for adjusting delivery pressure
- Large sensitive diaphragm for reliable pressure control
- Maximum inlet pressure 250 psig
- Needle valve on outlet is standard

### HOW TO ORDER

Model Number	Del. Press. Range psig	Del. Press. Gauge psig	Inlet Press. Gauge psig
3701	2-25" water	0-30" water	none
3702	0.5-5 psig	0-10 psig	none

## Two-stage General Purpose Regulators for Low Pressure Delivery

When source gas pressures exceed 250 psig, this hybrid regulator created by coupling a Series 3700 regulator with a Series 2701 single stage regulator is an ideal choice for such higher pressure applications



### MATERIALS OF CONSTRUCTION

First Stage See model 2701 on page 22  
 2nd Stage See above

### HOW TO ORDER

Model Number	Del. Press. Range psig	Del. Press. Gauge psig	Inlet Press. Gauge psig
2701HY3701-CGA*	2-25" water	0-30" water	0-4000 psig
2701HY3702-CGA*	0.5-5 psig	0-10 psig	0-4000 psig

\*Specify CGA connection when ordering. If you do not desire the standard outlet valve add the suffix "NV" to the part number.

# HIGH PRESSURE REGULATORS

## Series 3800V

### DESCRIPTION

These series 3800V regulators feature a compact, reliable piston design for precise gas control at higher inlet pressures. They are designed for non-corrosive gas service and are especially suited for dead-end pressurized systems, such as pressure vessel testing.

### FEATURES

- Piston type actuation.
- Cartridge type seat assembly.
- Delrin cap bushing for smooth adjustment.
- Easily panel mounted with optional panel mount nuts.
- Double filter protection

### SPECIFICATIONS

Maximum inlet: up to 6000 psig  
Operating temperature: 0° to 140°F.  
Cv factor: 0.103  
Outlet port: 1/4" NPT female  
Outlet Connection: 1/4" stainless steel  
compression fitting  
Weight: 4 lbs.  
Dimensions: 6"W x 6-1/2"H x 6-1/4"



### MATERIALS OF CONSTRUCTION

Body: machined brass  
Bonnet: machined brass  
Piston: brass  
Inlet filter: bronze  
Seat: Kel-F®  
Seals: Viton®  
Gauges: brass

### HOW TO ORDER

Model Number	Del. Press. Range psig	Del. Press. Gauge psig	Inlet Press. Gauge psig
3800V-750-CGA*	50-750	0-1000	0-6000
3800V-1500-CGA*	100-1500	0-2000	0-6000
3800V-3000-CGA*	200-3000	0-4000	0-6000
3800V-4500-CGA*	300-4500	0-6000	0-6000

\* Specify CGA Connection when ordering.

# HIGH PRESSURE REGULATORS

## Series 3860T

### DESCRIPTION

The Series 3860T high pressure regulators are designed to safely reduce inlet pressures from cylinders filled with gases to 6000 psig. The self-venting feature of the regulator allows the operator to reduce the pressure setting in a closed system by venting the downstream pressure through the regulator.

### FEATURES

- Full 6000 psig delivery pressure capability.
- Available in brass or stainless steel.
- Self-venting design for ease of pressure adjustment.
- Unbalanced stem assures positive shut-off.
- Removable valve assembly module permits ease of repairs.
- Large adjusting knob provides fast low-torque pressure settings.



### SPECIFICATIONS

Maximum Inlet:

brass	6000 psig
stainless steel	10000 psig
Operating temperature:	40° to 165°F.
Cv factor:	0.06
Leakage:	bubble-tight
Inlet and Outlet ports:	1/4" NPT female
Weight:	5 lbs.

### MATERIALS OF CONSTRUCTION

	<b>3860TB</b>	<b>3860TS</b>
Body:	brass	303 stainless steel
Bonnet:	brass	nickel plated brass
Main valve seat:	Vespel	Vespel
Vent valve seat:	Kel-F®	Kel-F®
Seals:	Buna-N	Buna-N
Back-up rings:	Buna-N and Teflon®	Buna-N and Teflon®
Gauges:	brass	316 stainless steel

### HOW TO ORDER

Model Number	Del. Press. Range	Del. Press. Gauge	Inlet Press. Gauge**
	psig	psig	psig
3860TB-800-CGA*	0-800	0-1000	0-7500
3860TB-1500-CGA*	10-1500	0-3000	0-7500
3860TB-2500-CGA*	15-2500	0-3000	0-7500
3860TB-4000-CGA*	25-4000	0-6000	0-7500
3860TB-6000-CGA*	50-6000	0-7500	0-7500
3860TS-800-CGA*	0-800	0-1000	0-10,000
3860TS-1500-CGA*	10-1500	0-3000	0-10,000
3860TS-2500-CGA*	15-2500	0-3000	0-10,000
3860TS-4000-CGA*	25-4000	0-6000	0-10,000
3860TS-6000-CGA*	50-6000	0-10,000	0-10,000

\*Specify CGA connection when ordering.

Add prefix "NV" to model number if self-venting feature is not desired (i.e. NV3860TB-6000-677)

Self-venting feature is not recommended with flammable or toxic gases.

\*\*Regulators fitted with a CGA connection rated for 3000 psig will have a 0-4000 psig brass, or 0-3000 psig SS inlet pressure gauge.

# GENERAL PURPOSE NON-CORROSIVE GAS 1-STAGE REGULATOR Series 2700

## DESCRIPTION

The Series 2700 single stage regulators are specifically designed as an economical instrument for use in non-critical applications involving inert and non-corrosive gases. The are particularly suited to closely monitored applications. The large neoprene diaphragm provides good sensitivity for pressure control. The Series 2700 should not be used in applications where inboard diffusion of atmospheric impurities water and oxygen or the outgassing of hydrocarbon based impurities will negatively impact the work being performed.

## FEATURES

- Large nylon reinforced diaphragm for sensitive pressure control.
- Needle valve installed in outlet.

## APPLICATIONS

The Series 2700 regulators are ideal for use with inert, flammable, and hydrocarbon gases used in non-critical specialty gas applications.

## MATERIALS OF CONSTRUCTION

Body: chrome plated brass  
 Nozzle: brass  
 Seat: polyurethane  
 Diaphragm : nylon reinforced neoprene  
 Inlet Filter : sintered bronze  
 Seals: nylon™



## SPECIFICATIONS

Max. Inlet Pressure: 3000 psig  
 Operating Temp. Range: 0° to +140° F  
 Body Inlet and Outlet: 1/4" NPT female  
 Valve outlet : 1/4" NPT male  
 Flow coefficient:  $C_v = 0.18$

## HOW TO ORDER

Model Number	Del. Press. Range psig	Del. Press. Gauge psig	Inlet Press. Gauge psig
2701-15-CGA*	0-15	0-30	0-4000
2701-40-CGA*	0-40	0-60	0-4000
2701-80-CGA*	0-80	0-100	0-4000
2701-125-CGA*	0-125	0-200	0-4000

\*Specify CGA Connection Number when ordering.

# GENERAL PURPOSE NON-CORROSIVE GAS 2-STAGE REGULATOR

## Series 2720

### DESCRIPTION

The Series 2720 two-stage regulators are specifically designed as an economical instrument for use in non-critical applications involving inert and non-corrosive gases. They are particularly suited to applications which will not be closely monitored and a constant delivery pressure is required from full to empty cylinder. The large second stage diaphragm provides very sensitive pressure control. The Series 2720 should not be used in applications where inboard diffusion of atmospheric impurities water and oxygen or the outgassing of hydrocarbon based impurities will negatively impact the work being performed.

### FEATURES

- Large 2.75" diameter second stage nylon reinforced diaphragm for sensitive pressure control.
- Needle valve installed in outlet.



### APPLICATIONS

The Series 2720 regulators are ideal for use with inert, flammable, and hydrocarbon gases used in non-critical specialty gas applications when constant delivery pressure is required from full to empty cylinder.

### SPECIFICATIONS

Max. Inlet Pressure:	3000 psig
Operating Temp. Range:	0° to +140° F
Body Inlet and Outlet:	1/4" NPT female
Valve outlet:	1/4" NPT male
Flow coefficient:	$C_v = 0.08$

### MATERIALS OF CONSTRUCTION

Body:	chrome plated brass
Nozzles:	brass
Seats:	polyurethane
Diaphragms:	nylon reinforced neoprene
Inlet Filter :	sintered bronze
Seals:	nylon™

### HOW TO ORDER

Model Number	Del. Press. Range psig	Del. Press. Gauge psig	Inlet Press. Gauge psig
2721-15-CGA*	0-15	0-30	0-4000
2721-40-CGA*	0-40	0-60	0-4000
2721-80-CGA*	0-80	0-100	0-4000
2721-125-CGA*	0-125	0-200	0-4000

\*Specify CGA Connection Number when ordering.

## LECTURE BOTTLE EQUIPMENT

Due to the small size and limited contents of lecture bottles, special equipment is recommended for use. This special equipment is described here and on the following page.

### LECTURE BOTTLE REGULATORS

#### SERIES 3900

The Series 3910 regulator is designed for use with non-corrosive, non-toxic gases in lecture bottles. The Series 3920 lecture bottle regulator is designed for use with corrosive, and/or toxic lecture bottle gases. These light weight, compact single stage regulators incorporate many features found in our larger high purity regulators.

#### FEATURES

- Small compact design.
- Needle valve installed on outlet.

#### SPECIFICATIONS

	Series 3910	Series 3900
Max. Inlet Pressure:	3000 psig	3000 psig
Operating Temp. Range:	0 to +140°F	-40 to +140°F
Flow Coefficient (Cv):	0.02	0.06
Body Inlet Connection:	1/8" NPT female	1/8" NPT female
Body Outlet Connection:	1/4" NPT female	1/8" NPT female
Outlet Valve Connection:	1/4" NPT male	1/8" NPT male



Series 3910



Series 3920

#### MATERIALS OF CONSTRUCTION

	Series 3910	Series 3920	Series 3900
Body:	chrome-plated brass	316 stainless steel	Aluminum
Internal Seals:	nylon	Teflon® & Kel-F®	Teflon® & Kel-F®
Seat:	polyurethane	Teflon PFA®	Teflon PFA®
Diaphragm:	neoprene	316 stainless steel	316 stainless steel
Filter:	50 micron sintered bronze	50 micron stainless steel	50 micron stainless steel
Bonnet:	chrome plated brass	anodized aluminum	anodized aluminum
Gauges:	chrome plated brass	stainless steel	brass
Outlet Valve:	chrome plated brass	stainless steel	brass

#### HOW TO ORDER

Model Number	Del. Press. Range psig	Del. Press. Gauge psig	Inlet Press. Gauge psig
3910-15-170	2-15	0-30	0-4000
3910-60-170	4-60	0-100	0-4000
3910-15-180	2-15	0-30	0-4000
3910-60-180	4-60	0-100	0-4000
3900-30-170	2-30	0-60	0-3000
3900-30-180	2-30	0-60	0-3000
3900-60-170	2-60	0-100	0-3000
3900-60-180	2-60	0-100	0-3000
T3920-30-180	2-30	0-60	0-3000
T3920-60-180	2-60	0-100	0-3000

## LECTURE BOTTLE EQUIPMENT

### LECTURE BOTTLE HOLDERS

Lecture bottles have rounded ends and require some means of support when in use. We provide two types of holders here that meet most requirements.

#### NON-TIP STAND - MODEL 475

This stand offers a convenient method of securing a lecture bottle on a table or lab bench. The stand is made of light weight brushed aluminum and, yet the large diameter base provides stability even when a regulator is installed on the bottle.

#### WALL MOUNT LECTURE BOTTLE BRACKET MODEL 480

This bracket is made of powder coated steel and has spring steel clips that provide firm, secure support to the lecture bottle. The bracket is ideal for securing lecture bottles to lab cart or bench set-ups, in carrying cases for portable systems, or in storage cabinets.



475

480

### LECTURE BOTTLE CONTROL VALVES

These valves are specifically designed for attachment to lecture bottles to dispense their contents. They do not control pressure and should only be used when the operator is in attendance.



### MATERIALS OF CONSTRUCTION

	3990	3991	3992	3993
Body	brass	brass	316 stainless steel	aluminum-silicon-bronze
Stem	303 stainless steel	303 stainless steel	316 stainless steel	monel®
Packing	Teflon®	Teflon®	Teflon®	Teflon®
Tubing	hose barb	brass	316 stainless steel	monel®

### HOW TO ORDER

Model	Inlet Connection	Outlet Connection
3990-CGA	Specify CGA 170 or 180	1/4" O.D. hose barb
3991-CGA	Specify CGA 170 or 180	1/4" compression fitting w/10" long brass tubing
3992-180	CGA 180	1/4" compression fitting w/10" long SS tubing
3993-ASB-180	CGA 180	1/4" compression fitting w/10" long monel® tubing

# LASER CUTTING PRESSURE REGULATOR

## Series 3850

### DESCRIPTION

The 3850 regulator is specifically designed to meet the requirements of the laser cutter. It has fast on-off-on response, high flow capacity and delivers the pressures required for the job. Whether your gas source is cryogenic or high pressure, this series of regulator can handle the job.

The regulator is actually two regulators in one body. A dome loaded piston regulator and an integral spring loaded pilot regulator to feed the dome and set the regulated delivery pressure of the dome. The pilot regulator is supplied with gas from the inlet side of the dome-loaded regulator. A bleed flows out of the dome to the downstream system to permit a decrease in regulated pressure.

### FEATURES

- Rapid on-off-on response even at high flow rates
- 1/4" NPT female inlet and outlet connections
- High flow capacity  $C_v = .5$
- Built-in dome loader regulator
- 40 micron internal filter to limit particulate line contamination



### SPECIFICATIONS AND MATERIALS OF CONSTRUCTION

Max. inlet pressure	3000 psig
Outlet pressure range	0-500 psig
Body	brass
Seat and seals	PTFE
O-rings	Viton
Interconnection tubing	316 stainless steel
Operating Temp.	-40 to 140°F

### HOW TO ORDER

Model	Delivery Pressure Gauge psig	Inlet Pressure Gauge psig
3850L	0-1000	0-1000
3850H	0-1000	0-4000

### Options

9560A-P8FF brass line valve with  $C_v = 2.95$   
7510-100-P8MM brass 100 micron 1/4" NPT male inline filter  
7510-100-P8FF brass 100 micron 1/4" NPT female inline filter

# LASER WELDING GAS SUPPLY SYSTEMS

## DESCRIPTION

Each of the manufacturers of laser gas welding systems has their own specifications for the gas transfer system. The systems presented here generally meet or exceed the requirements of virtually all of the manufacturers. The manual, semi-automatic, and fully automatic systems have worked very successfully in many laser applications and contain all of the basic components required to protect the laser and maintain gas purity and flow. If for any reason, one of these systems does not meet your requirements contact us to discuss a custom system that is correct for your laser.

## FEATURES

- All high purity construction.
- Purge assemblies installed on each pigtail to ensure cylinder-to-cylinder purity on change-outs. (Cylinder connections with integral check valves in place of purge assemblies are available as an option).
- Built-in safety relief valve prevents laser over pressurization.
- Built-in 2 micron filter eliminate particulate contamination of the laser.
- Pigtails are 3' stainless steel flexible hose with stainless steel inner core to ensure contamination-free gas transfer and eliminate helium diffusion leakage.
- Convenient wall mounting bracket provided.
- High purity brass pressure regulator(s) with stainless steel diaphragms included.
- Designed to provide continuous gas flow to laser during cylinder change-outs.



## SPECIFICATIONS AND MATERIALS OF CONSTRUCTION

Max. inlet pressure	3000 psig
Inlet pressure gauges	0-4000 psig
Outlet pressure range	0-100 psig
Outlet pressure gauge	0-200 psig
Safety relief valve	set @ 100 psig
Outlet line filter	2 micron sintered stainless steel
Body	brass
Diaphragms	stainless steel
Seats and seals	Teflon, Tefzel, or Kel-F
Pigtails	316 stainless steel with brass cylinder connections
Operating Temp.	-40 to 140°F

## HOW TO ORDER

Model*	Changeover Control
917-LASER-CGA-4610	manual system with purge assemblies on pigtails
917-LASER-CV-CGA	manual system with integral check valves, but no purge assemblies
914-LASER-CGA-4610	914 semi-automatic changeover manifold (see page 72) with purge assemblies
914-LASER-CV-CGA	914 semi-automatic changeover manifold (see page 72) with integral check valves, but no purge assemblies
918E-LASER-CGA-4610	918E fully automatic changeover manifold (see page 70) with purge assemblies
918E-LASER-CV-CGA	918E fully automatic changeover manifold (see page 70) with integral check valves, but no purge assemblies

\* Specify CGA connection when ordering

## Options\*\*

- 917PS-XXX pressure switch alarm assembly (XXX – specify pressure setting desired 300 psig recommended)
- 912-AVA audio/visual alarm module for 917 gas transfer system
- 914-3B pressure switch alarm assembly (XXX – specify pressure setting desired 300 psig recommended)
- 914-AVA audio/visual alarm module for 914 changeover manifold

\*\*918E changeover manifold has a built-in alarm system as standard

## **LASER ASSIST/CRYOGENIC CONTAINER REGULATOR**

### **Series HL3300**

#### **DESCRIPTION**

This chrome plated brass single stage regulator is ideal for controlling the gaseous withdrawal from cryogenic containers, as a high flow line regulator, and to control laser assist gas.

The regulator boasts a large stainless steel diaphragm for better control and a 0.37 Cv to provide high flow if required.

#### **FEATURES**

- Available in three delivery pressure ranges, 0-125, 0-350, and 0-500 psig
- Maximum inlet pressure – 3000 psig
- One-piece encapsulated seat design with 10 micron filter to protect seat from particulate contamination
- Inlet is required CGA connection or 1/4" NPT female
- Outlet connection 1/4" NPT female
- $C_v = 0.37$



#### **MATERIALS OF CONSTRUCTION**

Body: Chrome plated brass forging

Bonnet: Chrome plated brass forging

Diaphragm: 302 stainless steel

Nozzle: brass

Seat & seals: PTFE Teflon

Filter: nickel plated sintered bronze

Seat return spring: PH 17-7 stainless steel

#### **HOW TO ORDER**

<b>Model Number</b>	<b>Del. Press. Range psig</b>	<b>Del. Press. Gauge psig</b>
HL3300-125-CGA*	0-125	0-200
HL3300-350-CGA*	0-350	0-400
HL3300-500-CGA*	0-500	0-1000

\* For line regulator use with 1/4" NPT female inlet and outlet substitute "P4FF" for CGA

#### **OPTIONS:**

1/4" compression outlet add "T4FS" to P/N

# BACK PRESSURE REGULATOR

## Series 3600

### DESCRIPTION

The 3600 Series are compact diaphragm-sensed back pressure regulators. The use of a diaphragm sensing mechanism provides greater sensitivity than common piston sensed designs. Back pressure regulators function like a safety relief valve except that they provide greater sensitivity, ease of adjustment and close pressure differential between opening and closing.

### FEATURES

- Sensitive diaphragm sensing
- High purity stainless steel diaphragm
- Easy adjustment
- Compact size
- Small pressure differential between open and closed
- Steady upstream pressure control

### APPLICATIONS

Back pressure regulators are ideal for a wide variety of applications. In gas chromatography laboratories they are installed at the outlet of carrier gas lines to ensure that the proper pressure is maintained on the GC system. They are used industrially to maintain blanket gas pressure on liquid storage tanks as they vary in fluid level and to maintain pressure on hydraulic lines, compressors and pumps.



### SPECIFICATIONS

Flow Coefficient(Cv): 0.3 (0.46 optional)  
 Inlet and Outlet Connections: 1/4" NPT female

### MATERIALS OF CONSTRUCTION

	3610	3620
Body	brass	316L stainless steel
Diaphragm	stainless steel	stainless steel
Diaphragm gasket	Teflon®	Teflon®
Seat	Teflon®	Teflon®
Nozzle	stainless steel	stainless steel
Seals	Teflon®	Teflon®
Bonnet	Chrome plated aluminum	Chrome plated aluminum

### HOW TO ORDER

Model Number*	Control Range (psig)	Control Range Gauge (psig)
3610-10	0-10	0-15
3610-25	0-25	0-60
3610-50	0-50	0-100
3610-100	0-100	0-200
3610-250	0-250	0-400
3610-500	0-500	0-1000
3620-10	0-10	0-15
3620-25	0-25	0-60
3620-50	0-50	0-100
3620-100	0-100	0-200
3620-250	0-250	0-400
3620-500	0-500	0-1000

\*To order the optional 0.46 Cv nozzle add suffix "HF" to part number

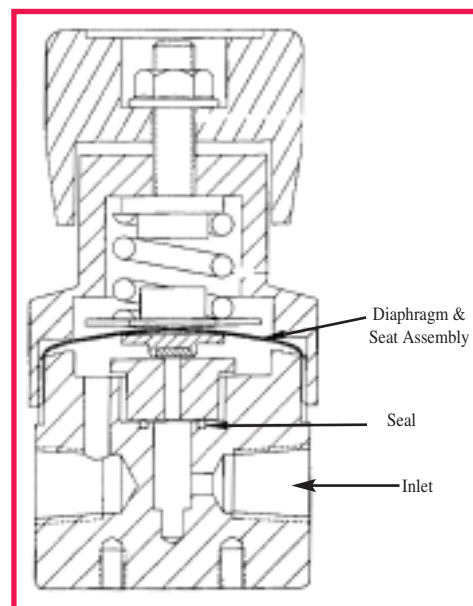

## LEAK-TECTOR™ TESTING SOLUTION

### DESCRIPTION

Leak-Tector is specially formulated for testing lines, cylinders, and systems carrying oxygen and other compressed gases for leaks. The formulation contains no oil, grease, fatty acids, ammonias, or any other ingredient that could combine with pure oxygen to form either a flammable or explosive mixture.

Leak-Tector is simple to use. Apply the solution to a connection or surface suspected of leaking and watch for bubble clusters. Large leaks form large bubble clusters. Very fine leaks form white foam that builds up for several minutes, making detection easy and certain. Solution dries clean with no greasy residue and does not need to be removed after testing. Tests have shown that Leak-Tector clearly detects leaks as small as one pound of gas in 100 years, a leak rate of  $1.16 \times 10^{-4}$  cc/sec of nitrogen.

Leak-Tector is available in convenient 8 oz. squeeze bottles or 1 gallon containers.



### SPECIFICATIONS

Temperature range: +35° to +160°F

Meets Air Force Spec. MIL-L-25567

### HOW TO ORDER

Model	Description
LT-8	8 oz squeeze bottle of Leak-Tector
LT-8X12	case of 12 8 oz bottles of Leack-Tector
LT-1G	one gallon bottle of Leak-Tector
LT-1GX4	case of four one gallon bottle of Leak-Tector

## FLOWMETER TUTORIAL

Flowmeters are used to measure the rate of flow of liquids or gases. They do not control the rate of flow unless they are equipped with a control valve or flow controller. There are two basic types of flowmeters; rotameters and electronic mass flowmeters. Mass flowmeters and mass flow controllers can be found on pages 36-39.

### ROTAMETERS

Rotameters are a simple, precise and economical way to measure flow rates. They consist of a precision tapered glass tube containing one or more spherical floats. A measuring scale is etched on the glass tube. The diameter of the tube at the bottom, or inlet is approximately equal to the diameter of the float.

As fluid enters the tube, the float rises to a point where the area between the float and the tube wall is large enough to permit unrestricted flow, and the float is stationary. This position corresponds to a point on the tube scale and thus permits a reading of the rate of flow.

The capacity, or flow range of a tube can be varied by changing the float material. Materials of a lower density such as pyrex glass or sapphire give a lower flow capacity than materials of a higher density like tantalum or stainless steel (see Figure1).

Rotameters, unlike mass flowmeters, are affected by temperature and pressure variation (see Figure 2). When equipped with a control valve on the inlet, readings are correct as long as the outlet pressure is equal to the pressure at which the tube was calibrated. When a valve is installed on the outlet, the tube calibration pressure must match the inlet pressure to the flowmeter unit.

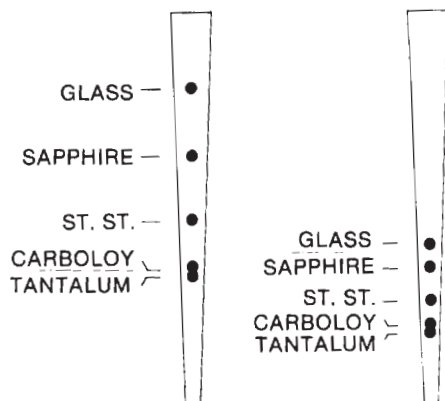

**Figure 1**  
Relative positions of floats of various densities for the same rate of flow with 1 atmosphere outlet pressure.

**Figure 2**  
Effect of float position for the same rate of flow in Figure 1, but with increased pressure at the flowmeter outlet.

## **FLOWMETER - Series 7920**

### **DESCRIPTION**

The 7920 flowmeters provide the most accurate indication and precise control of fluids available for a wide range of applications. This versatile meter is functionally and dimensionally interchangeable with other current designs while incorporating many innovative features.

All 7920 glass metering tubes have integral float guides to assure the accuracy of  $\pm 5\%$  of full scale. Glass and stainless steel floats are standard. The meters are available in a wide range of flows.

Standard with this series is the TUBE-CUBE™, a unique, design concept. The "cube," a unitized tube holder, aligns the tube quickly and easily for a simple tube installation or replacement, reduces chipped tube ends, broken tubes, and misalignment. The TUBE-CUBE™ also provides tube protection during handling and storage and affords a 1.5 X scale magnification factor for more accurate tube reading. End seals in the design are direct-acting and nonrotating for fast alignment and convenient service access.

### **APPLICATIONS**

- Carrier and fuel gas chromatography
- Atomic absorption
- Semiconductor manufacture
- Chemical processing
- General research and industrial uses

### **DESIGN FEATURES**

- High resolution 150mm scale length
- Many standard direct reading scales available
- Precision taper, fluted metering tube
- Lowest available pressure drop via maximum flow path area increases available flow rates at low feed pressures
- Standard front panel mounting requires minimum hardware - easy installation, quick access
- Available utility and high precision metering valves do not require special fittings
- Simplified; direct acting non-rotating compression seal



### **MATERIALS OF CONSTRUCTION**

End Blocks: Chrome plated Brass, 316 Stainless, or Monel®

"O" Rings & packing: Viton® - standard  
Buna-N, EPR rubber and teflon  
are available options

Side Plates: Anodized Aluminum

### **SPECIFICATIONS**

Maximum Pressure: 250 psig

Temperature Range: -20°F to +250°F  
-30°C to +120°C

Accuracy:  $\pm 5\%$  of full scale

Repeatability:  $\pm 0.25\%$  of scale reading

## Series 7920 Continued

Model	Material	Valve Type
B7920*	Brass	None
B7920V*	Brass	Standard
B7920HA*	Brass	High Accuracy
S7920	316 Stainless Steel	None
S7920V*	316 Stainless Steel	Standard
S7920HA*	316 Stainless Steel	High Accuracy
M7920*	Monel®	None
M7920V*	Monel®	Standard

\*Each model includes one tube from the table below; specify your choice when ordering.

### Options:

- 1/4" NPT female inlet & outlet" P4FF
- 1/4" hose barbs inlet and outlet - add suffix "HB" HB
- 1/4" compression tube fittings inlet and outlet T4FF
- 1/8" compression tube fittings inlet and outlet T2FF

### P/N Suffix:

P4FF

HB

T4FF

T2FF

### Bench stand - Model 7920B

**Eagle Eye Alarm - Model 7926-AVA\*\*** (Requires special modified unit - add prefix "EE" to model number)

## HOW TO ORDER

### Model -X-Y

X = tube required 1, 2, 3, 4, 5, 6, 7, 8, 10  
 Y = optional fittings HB = hose barbs

P4FF = 1/4" NPT female

T4FF = 1/4" compression

T2FF = 1/8" compression

**Example:** B7920V-2-T4FF is a brass unit with a 7920-2 flow tube and 1/4" compression fittings on inlet and outlet.

## FLOWMETER TUBES IN TUBE-CUBE®

Model	Typical Flow Range*		
	Float	Air scc/min.	Water cc./min.
7920-1	Glass	3 - 56	0.04 - 0.66
	St. Steel	11 - 158	0.12 - 3.18
7920-2	Glass	6- 91	0.08 -1.0
	St. Steel	16- 271	0.17 - 5.5
7920-3	Glass	22- 388	0.24 -7.8
	St. Steel	63- 845	0.68 -17
7920-4	Glass	64- 847	1 -17
	St. Steel	217- 1707	2 -46
7920-5	Glass	550- 2560	6 -54
	St. Steel	1070- 5080	21 -135
7920-6	Glass	610- 3830	9 -89
	St. Steel	1330- 7670	30 -217
7920-7	Glass	820- 8610	14 -200
	St. Steel	2090- 16580	53 -482
7920-8	Glass	2220- 24920	47 -568
	St. Steel	4190- 45940	102 -1319
7920-10	Glass	1.0- 100	

### Selected Correction Factors $flow = air\ flow \times correction\ factor$

Gas	Correction Factors
air	1.00
acetylene	1.054
ammonia	1.304
argon	0.851
n-butane	0.706
carbon dioxide	0.811
carbon monoxide	1.017
ethane	0.981
ethylene	1.016
helium	2.689
hydrogen	3.810
methane	1.343
nitrogen	1.017
nitrous oxide	0.811
oxygen	0.951
propane	0.810

\*Actual flow rates will vary from one manufacturing lot to another. Calibration data is supplied for each tube shipped.



7926-AVA  
 (See page 39)

## **GAS PROPORTIONER**

### **Series 7950**

The gas proportioner meters the flow of each of two gases and mixes them thoroughly in a special mixing tube to produce homogeneous two-component mixtures.

Concentration accuracies of 10% of component value are maintained with a standard unit using typical calibration curves. (In a desired mixture of 1% of gas A and 99% of gas B, a concentration between .9% and 1.1% is maintained.) Individual units can be calibrated for non-corrosive gases to attain an accuracy of 5% of the component value. Individual calibration curves are supplied with these specially calibrated units.

The control valves are installed at the outlets making these gas proportioners back pressure compensated. The readings on the tubes are accurate regardless of the downstream pressure, so long as the inlet pressures are maintained at the levels for which the tubes were calibrated.

The unit is recommended for 50 psig pressure but can be used at any pressure between 10 and 200 psi.\*

These proportioners are available in both aluminum and stainless steel construction. When ordering a gas proportioner, specify the composition of the desired mixture, the gases, the discharge rate, and inlet pressure in addition to the model number.

\* For best performance, it is recommended that tubes have only one float.

#### **HOW TO ORDER**

All models include baseplate, mixing tube and two flowmeter tubes of your choice selected from page 33.\*

\* If unsure of correct tubes, provide the composition range of intended mixtures, total outlet flow and operating inlet pressure. We will select the tubes.

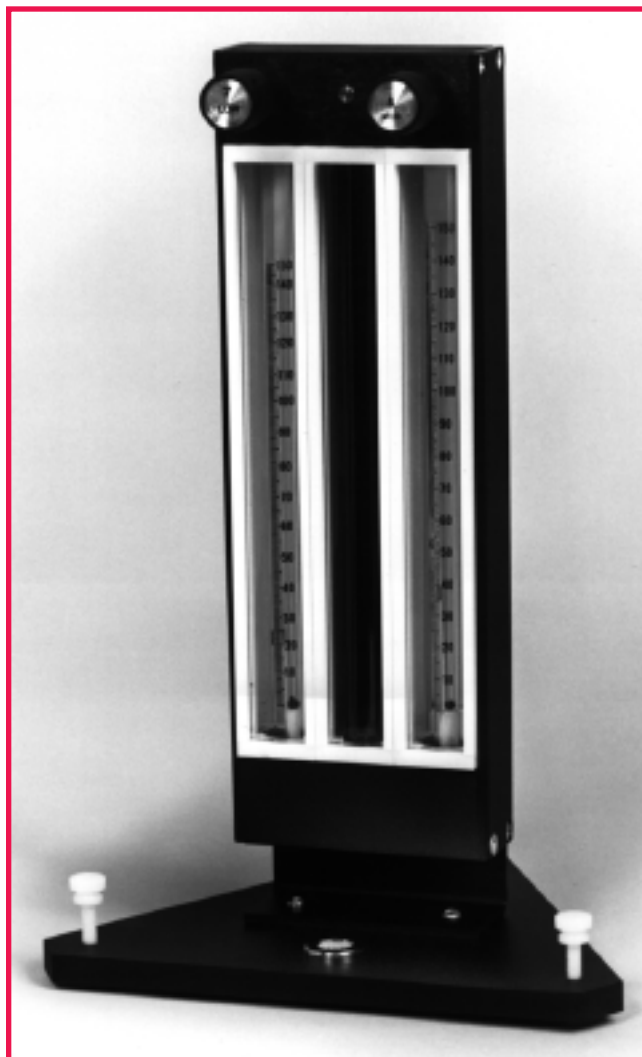

<b>Model</b>	<b>Material</b>	<b>Valve</b>	<b>Connections</b>
7951	Aluminum	Standard	1/8" NPT female
7951H	Aluminum	Standard	1/4" hose barb
7951T	Aluminum	Standard	1/4" compression
7952	Aluminum	High Accuracy	1/8" NPT female
7952H	Aluminum	High Accuracy	1/4" hose barb
7952T	Aluminum	High Accuracy	1/4" compression
7953	Stainless Steel	Standard	1/8" NPT female
7953H	Stainless Steel	Standard	1/4" hose barb
7953T	Stainless Steel	Standard	1/4" compression
7954	Stainless Steel	High Accuracy	1/8" NPT female
7954H	Stainless Steel	High Accuracy	1/4" hose barb
7954T	Stainless Steel	High Accuracy	1/4" compression

## LECTURE BOTTLE EQUIPMENT

### LECTURE BOTTLE HOLDERS

Lecture bottles have rounded ends and require some means of support when in use. We provide two types of holders here that meet most requirements.

#### NON-TIP STAND - MODEL 475

This stand offers a convenient method of securing a lecture bottle on a table or lab bench. The stand is made of light weight brushed aluminum and, yet the large diameter base provides stability even when a regulator is installed on the bottle.

#### WALL MOUNT LECTURE BOTTLE BRACKET MODEL 480

This bracket is made of powder coated steel and has spring steel clips that provide firm, secure support to the lecture bottle. The bracket is ideal for securing lecture bottles to lab cart or bench set-ups, in carrying cases for portable systems, or in storage cabinets.



475

480

### LECTURE BOTTLE CONTROL VALVES

These valves are specifically designed for attachment to lecture bottles to dispense their contents. They do not control pressure and should only be used when the operator is in attendance.



### MATERIALS OF CONSTRUCTION

	3990	3991	3992	3993
Body	brass	brass	316 stainless steel	aluminum-silicon-bronze
Stem	303 stainless steel	303 stainless steel	316 stainless steel	monel®
Packing	Teflon®	Teflon®	Teflon®	Teflon®
Tubing	hose barb	brass	316 stainless steel	monel®

### HOW TO ORDER

Model	Inlet Connection	Outlet Connection
3990-CGA	Specify CGA 170 or 180	1/4" O.D. hose barb
3991-CGA	Specify CGA 170 or 180	1/4" compression fitting w/10" long brass tubing
3992-180	CGA 180	1/4" compression fitting w/10" long SS tubing
3993-ASB-180	CGA 180	1/4" compression fitting w/10" long monel® tubing

## FLOWMETER Series 7965

The Series 7965 flowmeters use 65mm Tube-Cubes® with a single float. They are calibrated to read directly in SCCM, SLPM or SCFH of air. Correction factors are available for a number of common gases. The Series 7965 flowmeters are available in chrome plated brass or stainless steel.

### SPECIFICATIONS

Maximum Inlet Pressure: 250 psig  
 Temperature Range: -20° to +250°F  
 Valve: Standard or high accuracy needle valve  
 Dimensions: 1 1/4"W x 5 1/2"H x 2 3/4"D  
 Accuracy: ±5% full scale  
 Repeatability: 0.25% of scale reading  
 Inlet and Outlet: 1/8" NPT female

### FRAME WITH VALVE

Model	Material
7965B*	Chrome plated brass with standard valve
7965BHA*	Chrome plated brass with high accuracy valve
7965S*	316 Stainless Steel with standard valve
7965SHA*	316 Stainless Steel with high accuracy valve

\*Select flow tube from table on right.

### HOW TO ORDER

#### Model – X – Y

X=tube required

Y=optional fittings

**Example:** 7965B-J805-P4FF

#### Options:

- 1/4" NPT female inlet & outlet
- 1/4" hose barbs inlet and outlet - add suffix "HB"
- 1/4" compression tube fittings inlet and outlet
- 1/8" compression tube fittings inlet and outlet

#### P/N Suffix:

P4FF  
 HB  
 T4FF  
 T2FF

#### Bench stand - Model 7920B

**Eagle Eye Alarm - Model 7926-AVA\*\*** (Requires special modified unit - add prefix "EE" to model number)



7926-AVA  
 (See page 39)



### 65MM TUBE CUBE SELECTION

Tube Number	Float Material	Flow Range*
J07G	glass	0.6 – 6 sccm
J07ST	SS	2 – 17 sccm
J15G	glass	5 – 49 sccm
J15S	sapphire	7 – 72 sccm
J009	glass	10 – 130 sccm
J010	SS	30 – 300 sccm
J109	glass	50 – 500 sccm
J110	SS	100 – 1000 sccm
J703 (formerly 1B)	glass	0.05 – 0.5 slpm
J704	glass	0.1 – 1 slpm
J705 (formerly 2B)	SS	0.2 – 2 slpm
J802 (formerly 3B)	SS	0.5 – 6 slpm
J803 (formerly 4B)	SS	1 – 10 slpm
J854 (formerly 5B)	glass	2 – 25 slpm
J853	SS	4 – 40 slpm
J706	glass	0.1 – 1.2 SCFH
J707	glass	0.2 – 2 SCFH
J708	SS	0.5 – 5 SCFH
J755	SS	1 – 10 SCFH
J805	SS	2 – 20 SCFH
J859	glass	5 – 50 SCFH
J513	SS	10 – 100 SCFH
J514	carboly	10 – 150 SCFH

\*Other ranges available.

## ECONOMIC ACRYLIC FLOWMETER Series 7923

The Series 7923 acrylic flowmeters are an ideal low cost tool for measuring flow rates of inert and non-reactive gases. The 1/8" female standard inlet and outlet connections are contained in brass inserts to ensure a secure leak-free connection to prevent cracking of the acrylic body. A needle valve to control the flow rate is included.

### SPECIFICATIONS

Maximum inlet pressure: 100 psig  
 Maximum operating temperature: 150°F  
 Dimensions: 1" wide x 4" high x 2 1/8" deep  
 Accuracy: +5% full scale  
 Repeatability: +1% of scale reading  
 Inlet and Outlet: 1/8" NPT female standard on 3" centers  
 Seals: buna-N



Model	Flow Range (SCFH Air)	Float
7923-2A00	0.1 – 1 SCFH	glass
7923-2A01	0.2 – 2 SCFH	SS
7923-2A02	0.5 – 5 SCFH	glass
7923-2A03	0.5 – 10 SCFH	glass
7923-2A04	2 – 20 SCFH	SS
7923-2A05	3 – 30 SCFH	SS
7923-2A06	4 – 50 SCFH	glass
7923-2A07	10 – 100 SCFH	SS
7923-2A08	20 – 200 SCFH	SS
7923-2A12	0.04 – 0.5 slpm	glass
7923-2A13	0.1 – 1.0 slpm	SS
7923-2A29	0.2 – 2.5 slpm	glass
7923-2A14	0.4 – 5.0 slpm	glass
7923-2A15	1 – 10.0 slpm	SS
7923-2A16	2 – 25 slpm	glass
7923-2A17	4 – 50 slpm	SS
7923-2A18	10 – 100 slpm	SS

### Options:

- 1/4" hose barbs inlet and outlet - add suffix "HB"
- 1/4" compression tube fittings inlet and outlet - add suffix "T4FF"
- 1/8" compression fitting inlet and outlet - add suffix "T2FF"
- 7923-AVA alarm

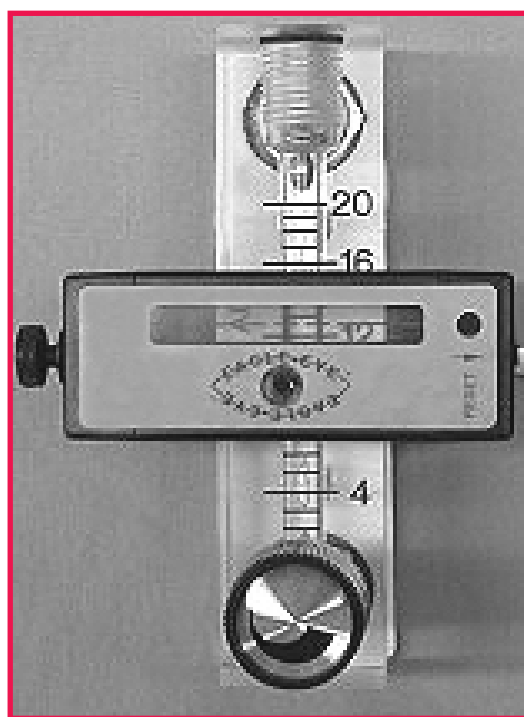

7923 flowmeter with Eagle-Eye alarm  
 See page 39.

# LARGE FLOW ACRYLIC FLOWMETERS

## Series 7974 & 7975

The Series 7974 and 7975 acrylic flowmeters are useful in a wide varied of of applications involving non-corrosive gases where flow rates exceed those of traditional laboratory models. All units have direct reading scales in either liters/minute or cubic feet/minute of air. Correction factors for other gases can be provided.

### FEATURES

- Easy to read scales.
- Air ranges from 14 lpm to 3400 lpm(0.5 to 100 scfm).
- Durable one-piece clear acrylic construction.
- Optional built-in cartridge type valve available.

### MATERIALS OF CONSTRUCTION

Body: clear acrylic

Fittings: 7974 series - brass

7975 series - PVC

Valve: brass

Seals: Buna-N

### SPECIFICATIONS

Max. Operating Pressure: 100 psig

Operating Temp. Range: 0° to +150° F

Body Inlet and Outlet: 7974 - 1/4" NPT female

7975 - 1" NPT female

Accuracy: 7974 Series - +3% of full scale

7975 Series - +2% of full scale

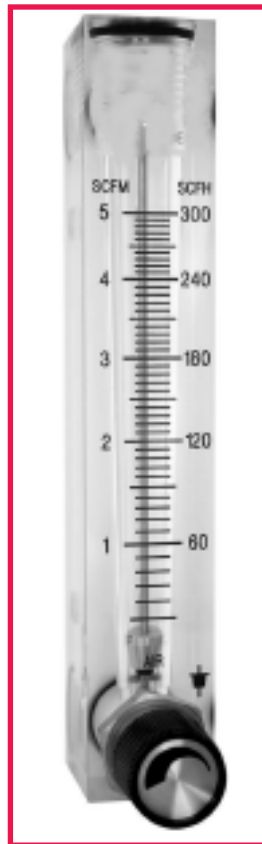

Series 7974

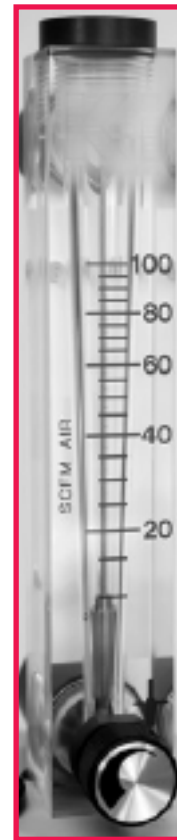

Series 7975

### HOW TO ORDER

Model Number	Flow Range
B7974-1	0.5- 5.0 SCFM
B7974-2	1- 10 SCFM
B7974-3	2- 20 SCFM
B7974-4	14- 140 lpm
B7974-5	30- 280 lpm
B7974-6	60- 560 lpm

Option: Inlet needle valve - add suffix "V" to model number, i.e. 7974V-1  
 7974-AVA alarm

Model Number	Flow Range
7975-1	3- 25 SCFM
7975-2	4- 50 SCFM
7975-3	10- 100 SCFM
7975-4	100- 700 lpm
7975-5	100-1400 lpm
7975-6	400-3400 lpm

Option: Inlet needle valve - add suffix "V" to model number, i.e. 7975V-1.  
 7975-AVA alarm

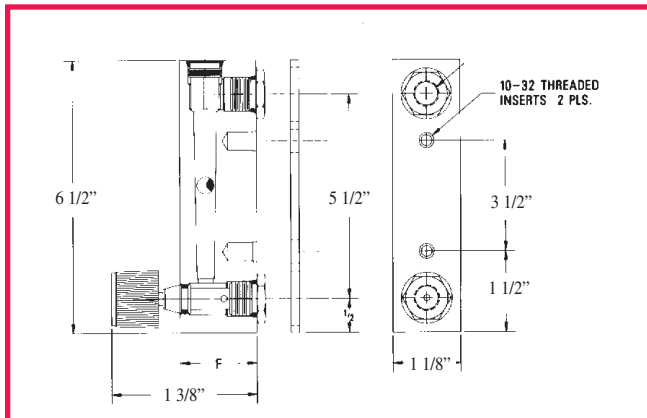

Series 7974

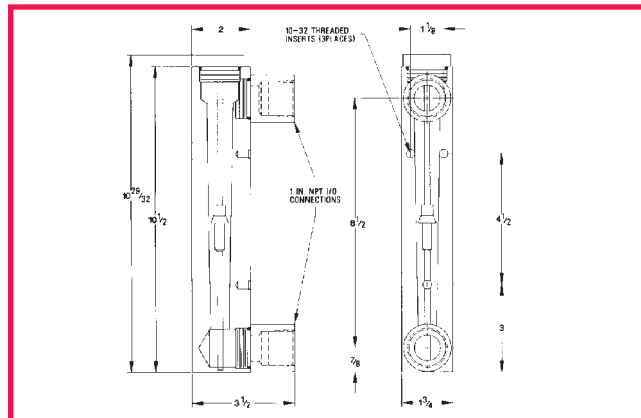

Series 7975

# EAGLE-EYE™ FLOWMETER ALARM

## Series 7900

### DESCRIPTION

The Eagle-Eye alarm is a non-contact sensor designed to alert the user when flow rates exceed defined thresholds. The Eagle-Eye alarm has red and green LED visual indicators and an audible buzzer indicator to provide flow rate status. A single unit can indicate either increased flow rate or decreased flow rate. The use of two units on a single flowmeter can provide both increasing and decreasing flow rates.

The Eagle-Eye is easily attached to any acrylic flowmeter of the 7923, 7974, or 7975 Series flowmeters shown on pages xx, xx, and xx.

### FEATURES

- Integral red and green LED indicators and an audible buzzer provide operating status
- Field installable while flowmeter is in service
- Non-contact sensor is not affected by the fluid in the flow stream
- Multiple operating modes
  1. Standard - unit will alarm until reset by the user
  2. Automatic reset - unit will alarm until flow returns to acceptable levels
- Multiple units may be installed on a single flowmeter to provide both high and low level alarms
- Rugged splash resistant enclosure
- Advance power supply provides a low level digital output representing the operating status

### SPECIFICATIONS

Body material - ABS  
 Spacer material - SBR  
 Operating temperature range: 32° to 160°F  
 Buzzer volume: 90 dB  
 Supply voltage: 5 VDC regulated  
 Supply current: 250 mA



Series 7900

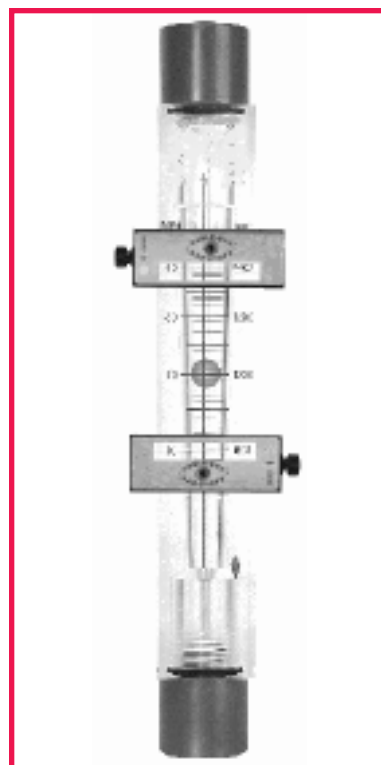

Series 7900

### HOW TO ORDER

Model	Description
7923-AVA	for use with 7923 series acrylic flowmeters on page 37
7926-AVA*	for use with 7920 and 7965 series on page 33 and 36
7974-AVA	for use with 7974 series acrylic flowmeters on page 38
7975-AVA	for use with 7975 series acrylic flowmeters on page 38
7920-PS	basic power supply for all models
7920-APS	advanced power supply with battery backup and 0-5 VDC logic output for all models

\* This unit can only be used on units with special side plates and Tube Cube assemblies.

## MASS FLOW CONTROLLERS

### Series 810C Mass-Trak

#### DESCRIPTION

Thermal mass flow controllers like the Series 810C Mass-Trak are more reliable than volumetric flow devices like rotameters because they are relatively immune to changes in gas temperature and pressure. Because these instruments measure molecular flow, they provide the most reliable, repeatable and accurate method of delivering gas to your system.

The 810C is designed to control the flow of non-corrosive gases. The instruments built-in display and set-point control eliminate the need for separate power supply and readout electronics, standard on most mass flow controllers. A straight, large diameter sensor tube prevents clogging and contamination. The fast response valve provides precise one-step control of critical gas flows. You simply, set it and forget it.

Available in flow ranges from 0-10 sccm to 0-50 slpm. The standard unit accepts 0-5 VDC or 4-20 mA command signals for applications that require remote set point control.

#### HOW IT WORKS

Gas enters the Mass-Trak and divides into two flow paths. Most of the flow goes through the laminar-flow bypass. This creates a pressure drop that forces a known fraction of the flow through the sensor tube. Two resistance temperature detector coils around the sensor tube direct a constant amount of heat into the gas stream. Heat transfer between these elements results in the interaction with the molecules of the flowing gas, independent of temperature and pressure fluctuations. The sensor signal is amplified, linearized and calibrated to achieve a direct reading of gas mass flow rate.

As the gas leaves the sensor and bypass, it flows through the servo-control valve. This valve is similar to an on-off solenoid valve, except that the current to the valve is modulated so that the valve plug assumes the exact height above the valve orifice necessary to maintain the valve's commanded flow. Built-in electronics allow Mass-Trak to maintain continuous proportional control by comparing the measured sensor signal to the command valve flow rate.



#### MATERIALS OF CONSTRUCTION

Wetted materials are: 10% glass-filled nylon 6/6  
316 stainless steel  
430F stainless steel  
nickel plating  
Viton o-rings

#### SPECIFICATIONS

Accuracy:	+1.5% of full scale
Repeatability:	+0.25% of full scale
Gas and ambient temperature:	32 to 120°F
Gas pressure:	20 psig optimum, 150 psig max.
Leak integrity:	1 x 10 <sup>-4</sup> ATM cc/sec of helium
Control range:	calibrated for 10 to 100% of full scale
Output signal:	linear 0-5 VDC into 2000 ohm minimum load resistance and linear 4-20 mA into 1000 ohm maximum load resistance (500 ohm-watt/15 VDC supply)
Response time:	1 second

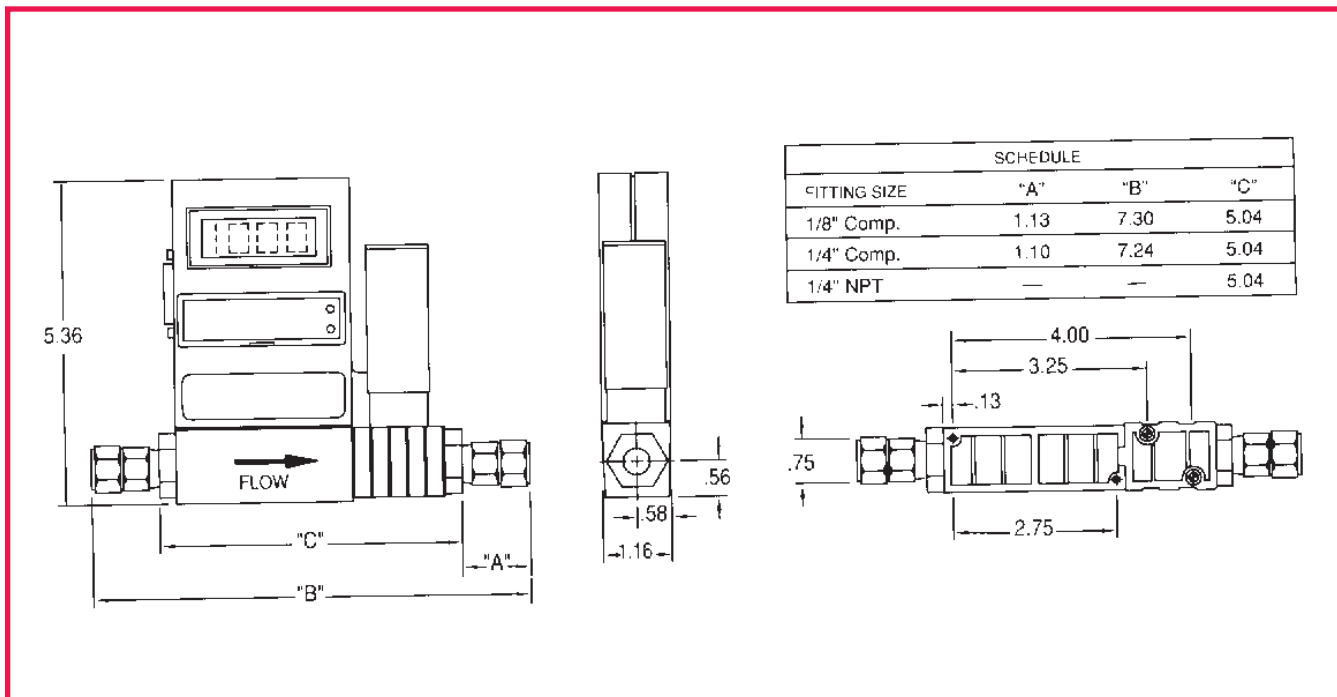

Series 810C Dimensional Drawing

## HOW TO ORDER

### P/N 810C-DR-W-X-Y-Z

(select X, Y, and Z parameters from table below)

W = inlet and outlet connections: P4FF = 1/4" NPT female  
 T2FF = 1/8" compression fittings (up to 15 slpm)  
 T4FF = 1/4" compression fittings

X = inlet and outlet pressure calibration: NF = normal pressure (up to 40 psig)  
 MP = 40-150 psig

Y = flow range:

0-10 sccm	= 00010
0-20 sccm	= 00020
0-50 sccm	= 00050
0-100 sccm	= 00100
0-200 sccm	= 00200
0-500 sccm	= 00500
0-1 slpm	= 01000
0-2 slpm	= 02000
0-5 slpm	= 05000
0-10 slpm	= 10000
0-20 slpm	= 20000
0-30 slpm	= 30000
0-40 slpm	= 40000
0-50 slpm	= 50000

All flows are based on standard conditions of 70°F and 1 ATM unless otherwise specified when ordering.

Z = factory set output option: V = 0-5 VDC  
 A = 4-20 mA

# MASS FLOWMETERS

## Series 820 Top-Trak

### DESCRIPTION

Thermal mass flowmeters like the Series 820 Top-Trak are more reliable than volumetric flow devices like rotameters because they are relatively immune to changes in gas temperature and pressure. Because these instruments measure molecular flow, they provide the most reliable and accurate method of delivering gas to your system.

The 820 is designed to measure the flow of non-corrosive gases. The instruments built-in display, power supply, and readout electronics, provides an easy and convenient method of accurately monitoring the gas flow of your system. A straight, large diameter sensor tube prevents clogging and contamination.

Available in flow ranges from 0-10 sccm to 0-40 slpm. The standard unit can be supplied with either 0-5 VDC or 4-20 mA output signals.

### HOW IT WORKS

Gas enters the Top-Trak and divides into two flow paths. Most of the flow goes through the laminar flow by-pass. This creates a pressure drop that forces a known fraction of the flow through the sensor tube. Two resistance temperature detector coils around the sensor tube direct a constant amount of heat into the gas stream. Heat transfer between these elements results in the interaction with the molecules of the flowing gas, independent of temperature and pressure fluctuations. The sensor signal is amplified, linearized and calibrated to achieve a direct reading of gas mass flow rate.

### MATERIALS OF CONSTRUCTION

Wetted materials are: 10% glass-filled nylon 6/6  
 316 stainless steel  
 nickel plating  
 Viton o-rings



### SPECIFICATIONS

Accuracy:  $\pm 1.5\%$  of full scale  
 Repeatability:  $\pm 0.5\%$  of full scale  
 Gas and ambient temperature: 32 to 120°F  
 Gas pressure: 20 psig optimum, 150 psig max.  
 Leak integrity:  $1 \times 10^{-4}$  ATM cc/sec of helium  
 Input power: 12-18 VDC  
 Output signal: linear 0-5 VDC standard  
 4-20 mA optional

Response time: 800 ms time constant  
 Pressure Coefficient: 0.02% of full scale per psi  
 (0.07 kg/cm<sup>2</sup>) or better

Pressure drop:	Flow Rate	Max. $\Delta P$
	SLM	cm of water
up to 10		7
20		25
30		47
40		88

Temperature coefficient: 0.15% of full scale per °C or better

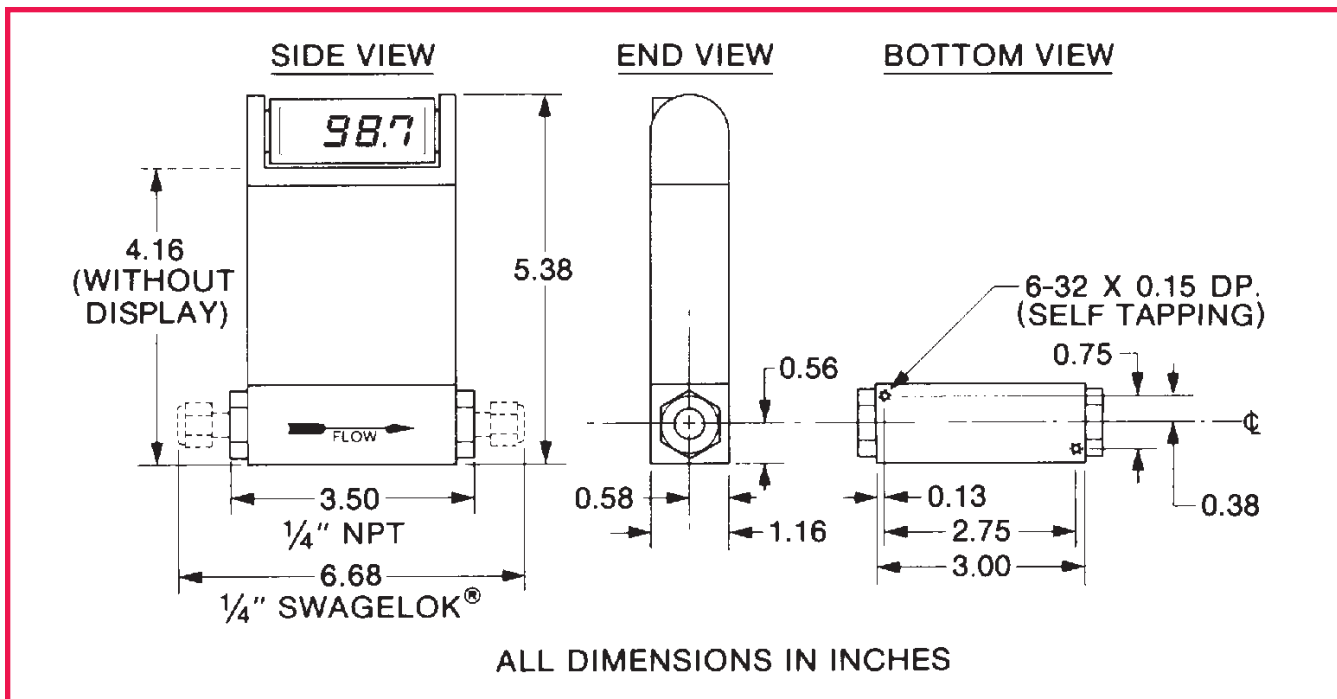

Series 820 Dimensional Drawing

How to Order

**822-W-X-Y-Z**

(select X, Y, and Z parameters from table below)

W = inlet and outlet connections: P4FF = 1/4" NPT female  
 T2FF = 1/8" compression fittings (up to 15 slpm)  
 T4FF = 1/4" compression fittings

X = inlet and outlet pressure calibration: NF= normal pressure (up to 40 psig)  
 MP = 40-150 psig

Y = flow range:

0-10 sccm	= 00010	
0-20 sccm	= 00020	
0-50 sccm	= 00050	
0-100 sccm	= 00100	
0-200 sccm	= 00200	
0-500 sccm	= 00500	
0-1 slpm	= 01000	All flows are based on standard conditions of 70°F and 1 ATM unless otherwise specified
0-2 slpm	= 02000	
0-5 slpm	= 05000	
0-10 slpm	= 10000	
0-20 slpm	= 20000	
0-30 slpm	= 30000	
0-40 slpm	= 40000	

Z = Output Signal: V = 0-5 VDC  
 A = 4-20 mA

## **GAS PURIFIERS-Model 8010 (for pressure applications up to 3000 psig)**

### **DESCRIPTION**

The model 8010 replaceable cartridge gas purifier is useful in many laboratory and industrial applications where the introduction of oil and/or water can result in poor performance or equipment shut-down. It is not uncommon to find varying levels of these impurities in some industrial gases and occasionally even in specialty carrier gases. The small daily operating costs are easily justified by the prevention of a system shut-down and the subsequent cleaning and/or repair costs.

The units are especially useful in GC carrier gas lines to ensure that undesirable moisture does not enter the instrument. Water can contribute to inaccurate results and the rapid deterioration of expensive chromatography column separation phases.

The model 8010 purifier shell must be used in conjunction with specially designed replaceable cartridges.

Models 8010-1, 8010-2, or 8010-3 are filled with various adsorbents. Model 8010-4 contains a 5 micron sintered bronze filter element. These are described below. These cartridges are shipped in hermetically sealed cans with convenient pull-tab tops for easy opening. This improved packaging ensures full retention of capacity in storage until the time of use.



### **MATERIALS OF CONSTRUCTION**

Shell body: anodized aluminum

Shell head: nickel plated brass

O-ring seal: buna-N

Cartridges: 8010-1 Molecular Sieve 13x  
 8010-2 Molecular Sieve 4A  
 8010-3 Activated Charcoal  
 8010-4 Sintered Bronze

### **SPECIFICATIONS**

Max. Operating Pressure: 3000 psig(500 psig for oxygen)

Operating Temperature: -40° to +165°F.

Inlet and Outlet Ports: 1/4" NPT female

Dimensions: 2" dia. x 5 3/4" long

Weight with Cartridge: 1.5 lbs.

Dew Point Achievable: -100°F.

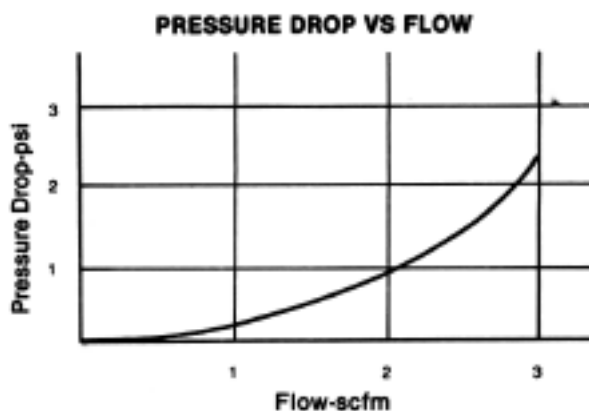

### **HOW TO ORDER**

<b>Model</b>	<b>Description</b>	<b>Absorption Capacity</b>	<b>General Application</b>
8010	Purifier Shell Only		
8010-1	Molecular Sieve 13x	6.5 grams water	Removal of oil & water
8010-2	Molecular Sieve 4A	7.2 grams water	Removal of water
8010-3	Activated Charcoal (Warning: Do not use with oxygen concentrations in excess of 21%)		Removal of heavy hydrocarbons acetone level control in acetylene used for atomic absorption
8010-4	5 micron sintered bronze element		Particulate removal

## **GAS PURIFIERS-Model 8000 (high capacity units)**

### **DESCRIPTION**

The model 8000 replaceable cartridge gas purifier is similar to the Model 8010 but is designed for higher capacities and a lower working pressure. The Model 8000 is constructed of an aluminum shell that accepts a large capacity cartridge. This shell may be permanently mounted when installed in the gas line and can be serviced without disturbing the line connections. Spring pressure holds the replaceable cartridge tightly against the bottom gasket to prevent the gas to be purified from bypassing the cartridge. The side inlet is located at the bottom of the unit oriented 90° from the outlet located at the top of the unit.

The model 8000 purifier shell must be used in conjunction with specially designed replaceable cartridges (Model 8000-1, 8000-2, or 8000-3) filled with various adsorbents. These are described below. These cartridges are shipped in hermetically sealed cans with convenient pull-tab ends for easy opening. This improved packaging ensures full retention of capacity in storage until the time of use.



### **MATERIALS OF CONSTRUCTION**

Shell body: anodized aluminum

Strainer Assembly: monel® and brass

Gaskets: Neoprene

Cartridges: 8000-1 Molecular Sieve 13x  
 8000-2 Molecular Sieve 4A  
 8000-3 Activated Charcoal

### **SPECIFICATIONS**

Max. Operating Pressure: 350 psig

Operating Temperature: -40° to +200°F.

Inlet and Outlet Ports: 1/4" NPT male

Dimensions: 4 3/4" dia. x 15 5/8" long

Weight with Cartridge: 14.3 lbs.

Dew Point Achievable: -100°F.

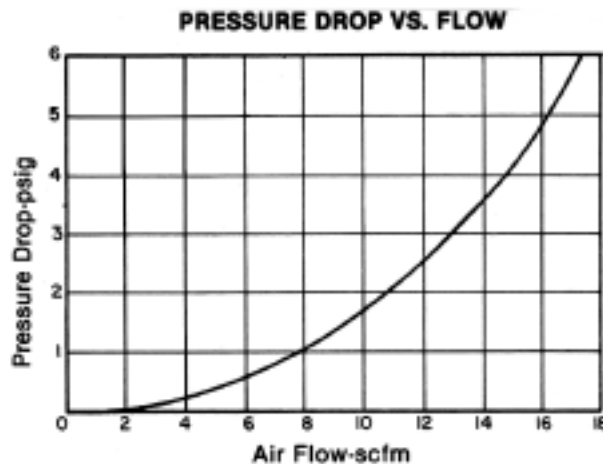

### **HOW TO ORDER**

Model	Description	Absorption Capacity	General Application
8000	Purifier Shell Only		
8000-1	Molecular Sieve 13x	126 grams water	Removal of oil & water
8000-2	Molecular Sieve 4A	134 grams water	Removal of water
8000-3	Activated Charcoal (Warning: Do not use with oxygen concentrations in excess of 21%)		Removal of heavy hydrocarbons acetone level control in acetylene used for atomic absorption

## OXYGEN TRAPS

### Series 6300

#### DESCRIPTION

These Series 6300 oxygen traps contain a highly active, metal-containing, inert supported reagent filled into a one-piece aluminum container. The trap is capable of reducing the oxygen content of a gas stream down to 99.99998% of its original concentration. Each unit is filled under a heated flow of ultra high purity helium to eliminate the need for extensive purging prior to GC or GC/MS operation.

The Series 6300 units are ideal for use with hydrogen and inert carrier gases commonly used with TC and FID gas chromatographs as well as argon-methane mixtures used with electron capture gas chromatographs. The all metal housing virtually eliminates contamination and resultant signal noise that often occur with traps constructed of other materials. These units can also be used to treat carbon monoxide, carbon dioxide, alkanes, alkenes, aliphatic hydrocarbon gases and low boiling point aromatics, like benzene and toluene.

#### FEATURES

- Reduces oxygen levels to less than 15ppb.
- Scrubbing agent sphere size optimized to achieve maximum surface area and capacity to provide twice the surface area and capacity of "look-alike" units.
- Filter design and aspect ratio prevents channeling and promotes even flow and efficient scrubbing.
- Inlet and outlet fitted with 40 micron stainless steel frits.
- All metal construction.
- Bed material treated with ultra high purity helium.
- Operating pressure: 250 psig
- Oxygen removal capacity:   6300     630 mg  
  6350     2300 mg
- Dimensions:   6300    1.25" O.D. x 11.25" long  
                          6350    2 3/8" O.D. x 17" long

#### HOW TO ORDER

Model	Connections
6300-2*	1/8" tubing compression
6300-4*	1/4" tubing compression
6350-8*	1/2" tubing compression
6200C	mounting clip
8050C	mounting clip for 6350

\*Available with stainless steel compression fittings - add "SS" to part number

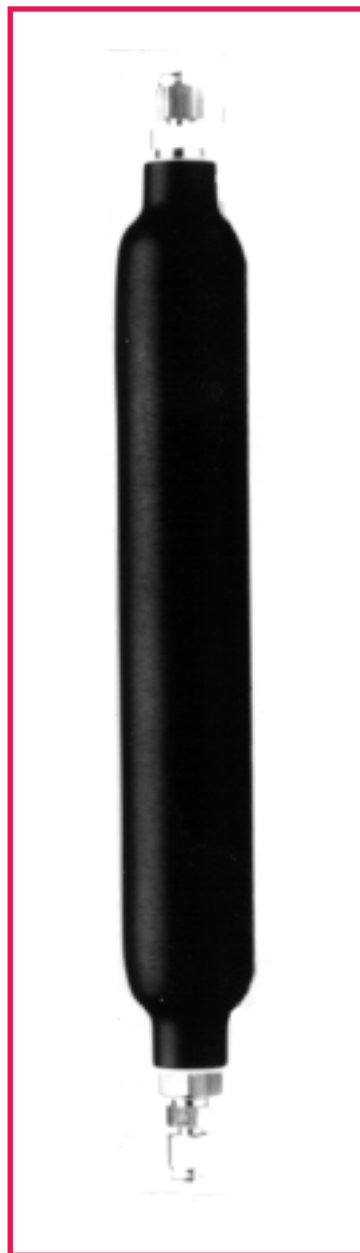

Gas traps should be mounted in a vertical position to ensure proper contact of the gas with the adsorbent. Use model 8012C mounting clip with 6300 Series oxygen trap.



6200C Mounting Clip

## INDICATING OXYGEN TRAP Series 6200

### DESCRIPTION

This unit is a step above other indicating oxygen traps. The unit comes to you completely assembled and ready for installation. It is ideal for use in-line directly after our Series 6300 oxygen removing trap to determine when to replace the larger unit. Used in this way the 6200 unit will last a considerable time if it is monitored regularly. A centimeter scale on the tube helps you to monitor the condition of the reactants.

The 6200 Series actually removes oxygen rather than convert it to another form of contamination. Oxygen reacts with the activated bed material to form manganese oxide that has a deep brown color providing a dramatic and progressive color change. The presence of moisture does not affect the oxygen removing capacity of the unit.

### FEATURES

- Reduces oxygen to less than 15 ppb.
- Reactive materials are contained in a glass tube protected by a clear plastic outer tube. The reactive materials are only in contact with glass and metal.
- Centimeter scale on reaction tube helps to monitor activity.
- The expended reactant material is non-hazardous, non-toxic, non-flammable, and non-reactive.
- Mounting clip available for convenient installation.
- Oxygen removing capacity: 6200 30mg  
6250 150mg
- Working pressure: 100 psig
- Dimensions: 6200 1.125" O.D. x 9.5" long  
6250 1.5" O.D. x 10.25" long

### HOW TO ORDER

Model	Connections
6200-2*	1/8" tubing compression
6200-4*	1/4" tubing compression
6250-2*	1/8" tubing compression
6250-4*	1/4" tubing compression
6200C	mounting clip for 6200
8012C	mounting clip for 6250

\*Available with stainless steel compression fittings - add "SS" to part number



6200C Mounting Clip



Gas traps should be mounted in a vertical position to ensure proper contact of the gas with the adsorbent. Use model 6200C mounting clip with 6200 Series hydrocarbon trap.

## **OXYGEN REMOVING PURIFIER FOR HYDROGEN**

### **Series 6210**

#### **DESCRIPTION**

The Series 6210 Purifiers remove oxygen from hydrogen by catalytic action. They are capable of removing up to 1% oxygen from a hydrogen stream down to a level of less than 1ppm. This reaction is normally accomplished at room temperature. At higher oxygen impurity concentrations, somewhat elevated temperatures may be experienced depending on operating conditions.

The purification is carried out by the formation of water from the oxygen impurity and the hydrogen background. If water presents a problem in your system it is suggested that a Model 8010 or 8000 purifier be installed in the system after the Series 6210 unit (see pages 44 and 45.)

The catalytic materials do not require regeneration and will function indefinitely providing that they are not contaminated. Sulfur and halogens are the primary contaminants of concern.



#### **HOW TO ORDER**

<b>Model</b>	<b>Max. Flow SCFH</b>	<b>Max. Oper. Press. psig</b>	<b>Connections female</b>	<b>Dimensions inches</b>
6210-10	10	2000	1/4" compression	1.05" dia. x 9.5" long
6210-25	25	2200	1/4" compression	1.32" dia. x 14.5" long
6210-50	50	1200	1/4" compression	1.66" dia. x 15" long
6210-100	100	1400	1/4" compression	2.38" dia. x 15.5" long
6210-200	200	1300	1/4" compression	2.88" dia. x 19.5" long
6210-500	500	900	1/2" compression	4.0" dia. x 23" long

## CO2 TRAP Series 6400

### DESCRIPTION

The 6400 Series carbon dioxide trap is designed to remove CO2 gas from air, argon, helium, hydrogen, or nitrogen. The trap body is constructed of borosilicate glass with nickel plated end fittings with stainless steel sintered frits.\* The absorption media is a formulation of sodium hydroxide and calcium hydroxide with an high absorptive capacity and indicating properties. Typically, this material will absorb 15-20% of its weight in carbon dioxide before the material is saturated and needs to be replaced. Replacement is indicated when the normally white color of the material turns violet. If moisture is detrimental to your system, a moisture trap should be installed down stream from this unit to adsorb water evolved from the absorption of the carbon dioxide (see page 50.)

\*Units with stainless steel fittings are also available. Add "SS" to part number.

### FEATURES

- Removes carbon dioxide to less than 0.5 ppm
- Inlet and outlet fitted with 40 micron stainless steel frits.
- Reaction with carbon dioxide indicted by color change from white to violet.
- CO2 removing capacity:
 

6410	45 grams CO2
6425	90 grams CO2
- Dimensions:
 

6410	1.5" O.D. x 12.5" long
6425	1.75" O.D. x 16.5" long

### HOW TO ORDER

Model	Description	End Fittings
6410-2	carbon dioxide trap - 100 cc	1/8" compression
6410-4	carbon dioxide trap - 100 cc	1/4" compression
8012C	mounting clip for 6410 trap	
6425-2	carbon dioxide trap - 250 cc	1/8" compression
6425-4	carbon dioxide trap - 250 cc	1/4" compression
8040C	mounting clip for 6425 trap	

\*Add suffix "SS" to part number for stainless steel compression fittings.



8012C  
 Mounting Clip



8040C  
 Mounting Clip

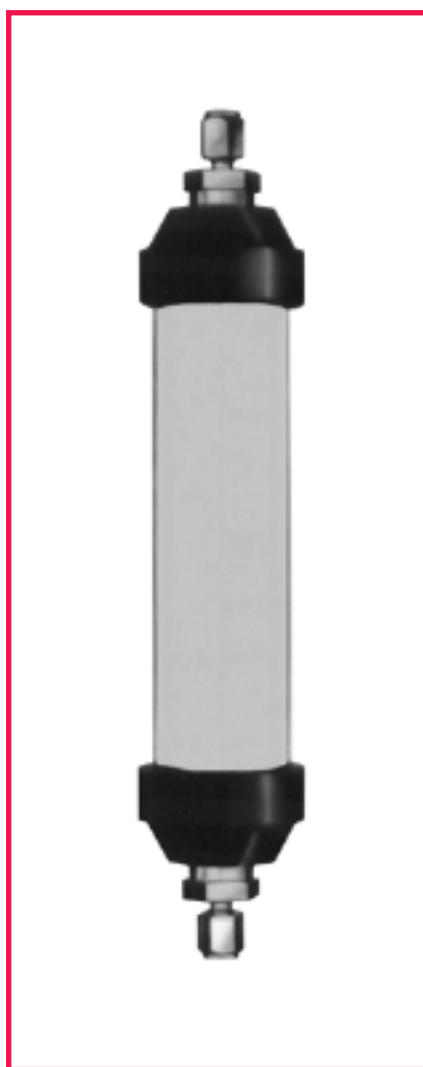

Gas traps should be mounted in a vertical position to ensure proper contact of the gas with the adsorbent. Use model 6400C or 8040C mounting clip with 6400 Series carbon dioxide trap.

## INDICATING MOISTURE TRAPS

### Series 8012, 8020, and 8040, 8050

#### DESCRIPTION

These units are designed to remove water, oil and organics from gases commonly used as gas chromatography carrier gases. They are constructed from Lexan® polycarbonate tubing with aluminum end caps sealed with Viton® o-rings, except for the 8050 which has a solid aluminum housing and is thus non-indicating. All units are filled with a mixture of molecular sieve 13X and indicating molecular sieve 4A. These are the highest capacity molecular sieves available and the preferred choice for gas drying. The blue indicating sieves turn buff color at 20% relative humidity.

#### FEATURES

- Reduces water to less than 20 ppb.
- Available in 3 sizes (120cc, 200cc, 400cc, 1600cc) that can easily be refilled.
- Inlet and outlet o-ring sealed connectors are equipped with 40 micron sintered stainless steel frits to prevent particulates from entering your system.
- Mixed spherically shaped 13X and 4A adsorbents provides superior bed packing with less resistance to flow.
- Mounting clip available for convenient installation.
- Moisture removal capacity:
 

8012	21.6 grams
8020	36.0 grams
8040	72.0 grams
8050	132 grams
- Dimensions:
 

8012-2 or -4	1.5" O.D. x 9.0" long
8020-2 or -4	1.5" O.D. x 12.5" long
8040-2 or -4	1.75" O.D. x 17.5" long
8050-8	2 3/8" O.D. x 17" long
- Working Pressure:
 

8012, 8020, 8040	125 psig
8050	250 psig

#### HOW TO ORDER

Model	Capacity	Connections
8012-2*	120 cc	1/8" tubing compression fittings
8012-4*	120 cc	1/4" tubing compression fittings
8020-2*	200 cc	1/8" tubing compression fittings
8020-4*	200 cc	1/4" tubing compression fittings
8040-2*	400 cc	1/8" tubing compression fittings
8040-4*	400 cc	1/4" tubing compression fittings
8040R	400 cc	Provides enough for three 120 cc, two 200 cc, or one 400 cc refill
8050-8*+	735 cc	1/2" tubing compression fitting
8050R	1500 cc	provides enough for two refill
8012C		for mounting 8012 and 8020 units
8040C		for mounting 8040 units only
8050C		for mounting 8050 units only

+8050 is a non-indicating trap

\*Available with stainless steel compression fittings - add "SS" to part number

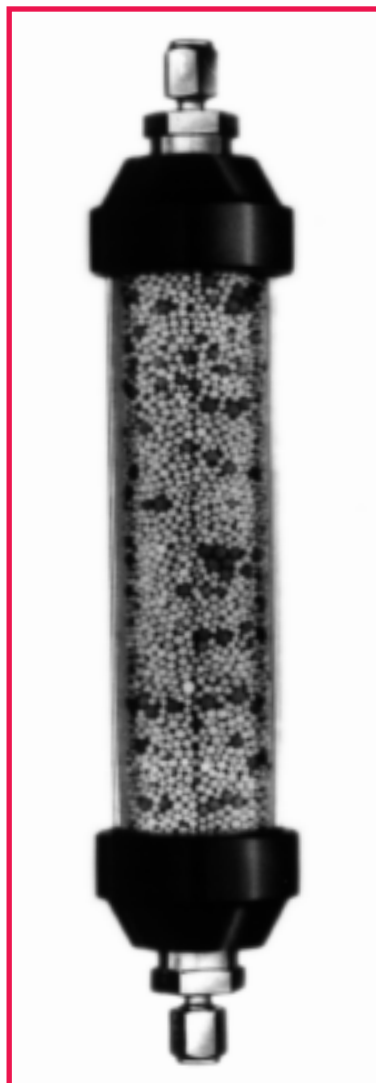

8012C  
 Mounting Clip

Gas traps should be mounted in a vertical position to ensure proper contact of the gas with the adsorbent. Use model 8012C, 8040C or 8050C mounting clip with 8012, 8020 and 8040 Series moisture traps.

## **HIGH CAPACITY INDICATING MOISTURE TRAP**

### **Series 8060**

#### **DESCRIPTION**

These traps are similar to the moisture traps on the opposite page but are capable of higher flow capacity and have greatly increased adsorption capacity. They are filled with a mixture of molecular sieve 13X and indicating molecular sieve 4A. These are the highest capacity molecular sieves available and the preferred choice for gas drying. The blue indicating sieves turn buff color at 20% relative humidity.

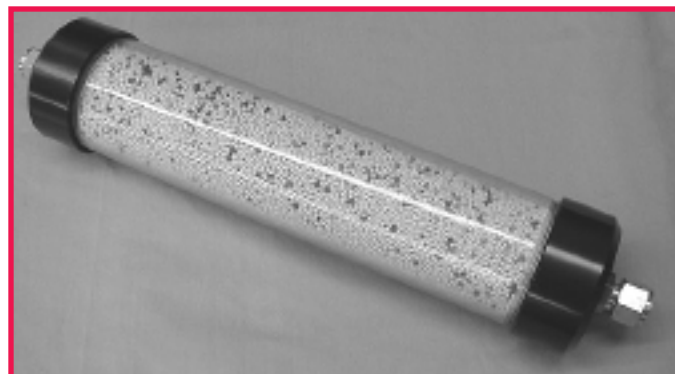

#### **FEATURES**

- Reduces water to less than 20 ppb
- Inlet and outlet o-ring sealed connectors are equipped with 100 micron stainless steel sintered frits to prevent particulates from entering your system.
- Field refillable.
- High flow capacity – up to 20 SCFM
- Maximum operating pressure – 125 psig
- Moisture removal capacity – 245 grams
- Dimensions – 19” long x 3” diameter
- Connections – stainless steel 1/2” tubing compression fittings

#### **HOW TO ORDER**

<b>Model</b>	<b>Capacity</b>	<b>Connections</b>
8060-8SS	1350	1/2” tubing stainless steel compression fittings
8060R		Provides enough molecular sieve mix for two refills
8060C		Mounting clip (two per unit suggested)

Gas traps should be mounted in the vertical position to ensure proper contact of the gas with the adsorbent. Two 8060C mounting clips are recommended for proper secure mounting.

## HYDROCARBON TRAPS

### Series 8200

#### DESCRIPTION

These units are designed to remove organics, such as alcohols, aromatics, chlorinated hydrocarbons, esters, ethers, hydrocarbons, and ketones from air, hydrogen, and inert carrier gases used in gas chromatography. They are constructed of aluminum and filled with extremely high surface area coconut shell based activated carbon.

The 8200 is a refillable purifier. Since impregnated carbons do not readily desorb all compounds, we recommend that the units be changed or refilled on a regular schedule using our 8200R refill kit that provides enough material for two charges of an 8200 or the 8250R which provides one charge of an 8250.

#### FEATURES

- Removes organics from air, hydrogen, and inert carrier gases. Does not remove light hydrocarbons like methane.
- Highly active coconut shell based carbon efficiently removes many types of hydrocarbon compounds.
- All metal housing.
- Refillable 200 cc or 1600 cc capacity.
- 40 micron filters on the inlet and outlet.
- Mounting clip available for convenient installation.
- Working pressure: 250 psig.
- Dimensions: 8200 1.5" O.D. x 12.5" overall length  
8250 2 3/8" O.D. x 17" overall length

#### HOW TO ORDER

Model	Connections
8200-2*	1/8" tubing compression fittings
8200-4*	1/4" tubing compression fittings
8250-8*	1/2" tubing compression fittings
8250R	Refill kit - contains 3 charge
8200R	Refill kit - contains 2 charges
8012C	Mounting clip
8050C	Mounting clip for 8250

\*Available with stainless steel compression fittings - add "SS" to part number



8012C  
Mounting Clip



Gas traps should be mounted in a vertical position to ensure proper contact of the gas with the adsorbent. Use model 8012C mounting clip with 8200 Series hydrocarbon trap.

# MOLECULAR SIEVES

## DESCRIPTION

Molecular sieves have a wide variety of uses in gas and chemical purification processes. We offer Types 3A, 4A, 5A, and 13X beads in a variety mesh sizes in the standard container sizes shown below. Custom packaging is also available.

**Beads offer some distinct advantages over pellets that are offered by competitors.**

- Beads provide a greater surface area per cubic foot resulting in more efficient adsorption for equivalent sized beds.
- Beads are stronger than pellets, thus they maintain their size and shape for more efficient adsorption.
- Beads do not create dust to the degree that pellets do; this results in a cleaner system with less frequent clogging of system filters.
- Beads offer an equivalent pressure drop to pellets.

### Molecular Sieve 3A Formula $K_{12}[(AlO_2)_{12}] \cdot X H_2O$

The potassium form of the Type A Crystal structure, is an alkalai metal alumino-silicate. Type 3A is used for drying polar liquids such as ethanol and methanol and the dehydration of unsaturated hydrocarbons such as acetylene, butadiene, and propylene.

### Molecular Sieve 4A Formula $Na_{12}[(AlO_2)_{12}] \cdot X H_2O$

The sodium form of the Type A Crystal structure, is an alkalai metal alumino-silicate. Type 4A is used for drying inert gases and saturated hydrocarbons, such as methane, ethane, and propane.

### Molecular Sieve 5A Formula $Ca_4,5Na_3[(AlO_2)_{12}] \cdot X H_2O$

The calcium form of the Type A Crystal structure, is an alkalai metal alumino-silicate. Type 5A is used for separating normal paraffins from branched-chain and cyclic hydrocarbons through a selective adsorption process.

### Molecular Sieve 13X Formula $Na_{86}[(AlO_2)_{86}(SiO_2)_{106}] \cdot X H_2O$

The sodium form of the Type X Crystal structure, is an alkalai metal alumino-silicate. Type 13X is used for general drying of inert gases and saturated hydrocarbons, purification of air through removal of water and carbon dioxide, and the removal of H<sub>2</sub>S and mercaptans from natural gas.

## HOW TO ORDER

Quantity		Type			
		3A	4A	5A	13X
<b>1/16" beads</b>	<b>8 x 12 mesh</b>				
1 x 1 lb.		MS1-3A001	MS1-4A001	MS1-5A001	MS1-13X001
6 x 1 lb		MS1-3A6X1	MS1-4A6X1	MS1-5A6X1	MS1-13X6X1
1 x 5 lbs.		MS1-3A005	MS1-4A005	MS1-5A005	MS1-13X005
4 x 5 lbs.		MS1-3A4X5	MS1-4A4X5	MS1-5A4X5	MS1-13X4X5
1 x 25 lbs.		—	—	—	MS1-13X025
1 x 30 lbs.		MS1-3A030	MS1-4A030	MS1-5A030	
1 x 55 lbs.		—	—	—	MS1-13X055
1 x 60 lbs.		MS1-3A060	MS1-4A060	MS1-5A060	
<b>1/8" beads</b>	<b>4 x 8 mesh</b>				
1 x 1 lb.		MS2-3A001	MS2-4A001	MS2-5A001	MS2-13X001
6 x 1 lb		MS2-3A6X1	MS2-4A6X1	MS2-5A6X1	MS2-13X6X1
1 x 5 lbs.		MS2-3A005	MS2-4A005	MS2-5A005	MS2-13X005
4 x 5 lbs.		MS2-3A4X5	MS2-4A4X5	MS2-5A4X5	MS2-13X4X5
1 x 25 lbs.		—	—	—	MS2-13X025
1 x 30 lbs.		MS2-3A030	MS2-4A030	MS2-5A030	
1 x 55 lbs.		—	—	—	MS2-13X055
1 x 60 lbs.		MS2-3A060	MS2-4A060	MS2-5A060	

## **FILTER APPLICATIONS**

### **GAS CHROMATOGRAPHY**

Particulates in an instrument carrier gas stream can reduce the overall performance of laboratory analytical work. Removing particles can reduce background noise levels and enhance instrument accuracy and precision.

### **PHARMACEUTICAL MANUFACTURING**

The capability of these filters to remove bacteria and other particulate matter enables pharmaceutical manufacturers to install a filter in gas lines to those systems requiring process, purge, or blanket gases, thus ensuring a virtually sterile gas atmosphere.

### **PNEUMATIC OPERATED DEVICES**

Because of the small orifices normally associated with these devices, they often malfunction and require frequent servicing. Installation of a particulate filter in the air or nitrogen feed lines helps to ensure longer trouble free operation, thus reducing down-time.

### **SEMICONDUCTOR MANUFACTURING**

With increasing levels of device density the effect of particulate contamination becomes more damaging to potential yields. Semiconductor manufacturers install these filters in virtually all their gas lines to reduce the effects of particulates and improve their production yields.

## **TEFLON® MEMBRANE GAS LINE FILTER 0.01 MICRONS Series 5000**

The Teflon® medium in this filter efficiently traps particles down to 0.01 microns. These units may be installed in gas lines supplied by cylinders or bulk sources. Both the materials and manner of construction render the Series 5000 units compatible with a wide variety of gases.

### **FEATURES**

- 100% efficient at 0.01 micron level.
- Filter medium - porous PTFE Teflon® membrane.
- All welded 316L stainless steel construction.
- Internal finish - less than 15 R<sub>a</sub>.
- 0.5 sq. ft. filter area provides high particle retention capacity.
- Excellent compatibility with a wide variety of gases.

### **SPECIFICATIONS**

Filtration: 100% @ 0.01 microns  
 Max. Operating Pressure: 1000 psig @ 70°F.  
 Max. Operating Temperature: 100°F.  
 Max. Flow: 250 slpm @ 15 psi ΔP



### **HOW TO ORDER**

Type of End Connection	Model Number	Connection Size		Dimensions			
		Inlet**	Outlet**	Length		Diameter	
				Inch	mm	Inch	mm
<b>Standard Pipe</b>	5000-P4FF	1/4" NPT female	1/4" NPT female	4.75	120.6	2.20	55.9
<b>Tubing Compression</b>	5100-T4FF	1/4" tubing compression	1/4" tubing compression	5.56	141.2	2.20	55.9
	5100-T8FF	1/2" tubing compression	1/2" tubing compression	5.81	147.6	2.20	55.9
<b>VCR® Compatible Face Seal</b>	5200-V4MM	1/4" face seal male	1/4" face seal male	5.62	142.7	2.20	55.9

\*\*Other end fitting configurations available on request.

## DEPTH GAS FILTERS - 0.2 MICRONS Series 7100

### DESCRIPTION

The Series 7100 depth filters are the workhorses of laboratories and many high purity industrial processes. They are routinely used in critical gas lines and as pre-filters to extend the lifetime of more expensive filtration units. They are designed to provide high filtration efficiency at an economical cost.

The Series 7100 filters employ a microporous fiberglass media held in a 316 stainless steel all welded housing. They are available in two sizes that accommodate most flow requirements.

### FEATURES

- 100% filtration efficiency at 0.2 micron level.
- All welded 316 stainless steel construction provides compatibility with a variety of gases.
- Long service life - particles are collected in the filter matrix throughout the depth of the filter.

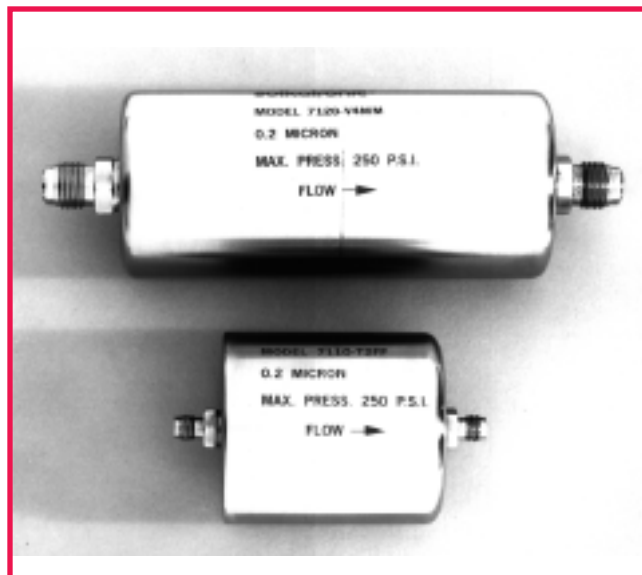

### SPECIFICATIONS

Filtration: 100% @ 0.2 microns  
 Max. Operating Pressure: 250 psig  
 Operating Temperature: 0° to 165°F.

### HOW TO ORDER

Type of End Connection	Model Number	Connection Size		Dimensions		Max. Flow@ 15 PSIG Inlet SLPM
		Inlet**	Outlet**	Inches Length	Dia.	
Standard Pipe	7110-P4FF	1/4 " NPT female	1/4" NPT female	3.00	1.66	100
	7120-P8FF	1/2 " NPT female	1/2" NPT female	4.07	2.38	500
Tubing Compression	7110-T4FF	1/4" tubing compression	1/4" tubing compression	4.09	1.66	100
	7120-T6FF	3/8" tubing compression	3/8" tubing compression	5.02	2.38	400
	7120-T8FF	1/2" tubing compression	1/2" tubing compression	5.30	2.38	500
VCR® Compatible Face Seal	7110-V4MM	1/4" face seal male	1/4" face seal male	3.74	1.66	100

\*\*Other end fitting configurations available on request.

# HIGH EFFICIENCY COALESCING FILTER

## Series 7300

### DESCRIPTION

These filters are ideal for removing liquid and solid contaminants, such as water, oil, and particulates, from air and inert gas streams. They are an excellent choice for purifying the air from oil lubricated compressors. Housing are constructed of aluminum with porting from 1/2" NPT female to 3/4" NPT female. A large range of flow rates are accommodated by this variety of size.

### FILTER ELEMENTS

**Coalescer Type 70C:** These elements have an efficiency rating of 95% against 0.1 micron particles and aerosols. They are a good choice for general purpose applications requiring clean compressed gas for powering valves, cylinders, air tools, etc.

**Coalescer Type 50C:** These elements have an efficiency rating of 99.99% against 0.1 micron particles and aerosols and should be used for the most demanding applications requiring a high quality clean gas. For the best performance, a Type 70C coalescer should be used as a pre-filter to the 50C.

**Adsorption Type CC:** Coalescing filters can only remove the oil and water present in gas lines as liquid aerosols. They cannot remove the small fraction of oil present as a true vapor or water vapor. Type CC cartridges are vapor adsorption filters which will remove such gaseous contamination. It is important to remember that Type CC cartridges must always be preceded by a Type 50C coalescing pre-filter.

### FEATURES

- Complete removal of oil, water and solids
- High flow rates with low pressure drop
- Low cost, completely disposable filter elements
- Wide selection of sizes
- Available with manual or fully automatic drains

### MATERIALS OF CONSTRUCTION

Housing	aluminum
Seals	Buna-N
Internals	models 7315, 7360 - nylon models 7370, 7380, 7385, 7390, 7395 SS/aluminum

### SPECIFICATIONS

Max. operating pressure: 250 psig

Max. operating temperature: 200°F



### Elements P/N

12-32-70C	25-127-70C	38-152-50C	51-476-50C
12-32-50C	25-127-50C	38-152-CC**	51-476-CC**
12-32-CC**	25-178-70C	51-230-70C	63-762-70C
25-64-70C	25-178-50C	51-230-50C	63-762-50C
25-64-50C	25-178-CC**	51-230-CC**	63-762-CC**
25-64-CC**	38-152-70C	51-476-70C	

\*CC cartridges are not used with automatic drains.

## HIGH EFFICIENCY COALESCING FILTER - continued

### Series 7300

#### HOW TO ORDER

Model	Port Size	Drain type	Dimensions (inches)			Filter Element P/N
			A	B	C	
7315-P4FF	1/4" NPTF	manual	0.39	1.57	4.45	12-32-xxx*
7360-P4FF	1/4" NPTF	manual	0.61	2.44	6.30	25-64-xxx*
7360-P8FF	1/2" NPTF	manual	0.61	2.44	6.30	25-64-xxx*
7360F-P4FF	1/4" NPTF	automatic	0.61	2.44	7.17	25-64-xxx*
7360F-P8FF	1/2" NPTF	automatic	0.61	2.44	7.17	25-64-xxx*
7370-P8FF	1/2" NPTF	manual	0.61	2.44	10.28	25-178-xxx*
7370F-P8FF	1/2" NPTF	automatic	0.61	2.44	10.28	25-127-xxx*
7380-P12FF	3/4" NPTF	manual	1.0	3.94	11.61	38-152-xxx*
7380F-P12FF	3/4" NPTF	automatic	1.0	3.94	11.61	38-152-xxx*
7380-P16FF	1" NPTF	manual	1.0	3.94	11.61	38-152-xxx*
7380F-P16FF	1" NPTF	automatic	1.0	3.94	11.61	38-152-xxx*
7385-P24FF	1.5" NPTF	manual	1.85	5.51	14.57	51-230-xxx*
7385F-P24FF	1.5" NPTF	automatic	1.85	5.51	14.57	51-230-xxx*
7390-P32FF	2" NPTF	manual	1.85	5.51	25.0	51-476-xxx*
7390F-P32FF	2" NPTF	automatic	1.85	5.51	25.0	51-476-xxx*
7395-P48FF	3" NPTF	manual	2.56	7.48	38.19	63-762-xxx*
7395F-P48FF	3" NPTF	automatic	2.56	7.48	38.19	63-762-xxx*

\* Select element from table on previous page.

## AIR FLOW RATES IN SCFM AT 2 PSI PRESSURE DROP

Housing Model	Line Size	Element Grade	Air Line Pressure (psig)								
			2	20	40	60	80	100	150	200	250
7315	1/4"	70C	4.4	9.0	12	20	25	30	43	56	69
		50C	1.3	2.7	4.3	5.9	7.4	9.0	12	17	21
		CC	0.7	1.5	2.4	3.3	4.1	5.0	7.2	9.4	12
7360 and 7360F	1/4" or 1/2"	70C	9.5	20	31	42	54	65	93	122	150
		50C	3.6	8	12	16	21	25	36	47	58
		CC	2.2	4.5	7.2	10	12	15	22	28	35
7370 and 7370F	1/2"	70C	22	45	72	98	125	150	215	280	345
		50C	8.7	18	29	39	50	60	86	112	138
		CC	5.8	12	19	26	33	40	57	75	92
7380 and 7380F	3/4" or 1"	70C	58	120	190	260	330	400	570	750	920
		50C	15	30	48	65	83	100	144	187	230
		CC	12	24	38	52	66	80	115	150	185
7385 and 7385F	1 1/2"	70C	116	240	380	520	660	800	1150	1500	1850
		50C	25	53	83	114	144	175	250	330	405
		CC	18	38	60	81	103	125	180	235	290
7390 and 7390F	2"	70C	205	425	670	910	1160	1400	2010	2620	3230
		50C	51	106	167	230	290	350	505	655	810
		CC	36	76	120	163	205	250	360	470	580
7395 and 7395F	3"	70C	400	835	1320	1800	2300	2800	4320	5900	7200
		50C	115	240	380	520	665	795	1226	1710	2100
		CC	80	170	270	365	470	560	864	1200	1450

# STAINLESS STEEL HIGH EFFICIENCY COALESCING FILTER

## Series 7130 and 7140

### DESCRIPTION

These filters are ideal for removing liquid and solid contaminants, such as water, oil, and particulates, from air, inert, and reactive gas streams. They are an excellent choice for purifying gas streams containing corrosive components. These filters fitted with a Type K fluorocarbon resin element are particularly suited for use in gas streams where highly reactive gases are being analyzed, since these elements exhibit very low levels of adsorption. Housing are constructed without welds of 316L stainless steel. They are available with porting of  $\frac{1}{2}$ " NPT female and  $\frac{1}{2}$ " NPT female.

### FILTER ELEMENTS

**Coalescer Type 70K:** These elements have an efficiency rating of 95% against 0.1 micron particles and aerosols. They are a good choice for general purpose applications requiring clean compressed gas.

**Coalescer Type 50K:** These elements have an efficiency rating of 99.99% against 0.1 micron particles and aerosols and should be used for the most demanding applications requiring a high quality clean gas. For the best performance, a Type 70K element should be used as a pre-filter to the 50K.

**Stainless Steel Type 01:** These elements are constructed of sintered stainless steel or stainless steel mesh. They are especially useful in highly contaminated gas streams as they may be cleaned and reused. They are available in filtering efficiencies of 1, 10, 25 and 100 microns.

### FEATURES

- Complete removal of solid and liquid contaminants from gas streams
- High flow rates with low pressure drop
- Selection of non-reactive or stainless steel filter elements
- Wide selection of sizes
- Relatively low internal volume

### MATERIALS OF CONSTRUCTION

Housing 316L stainless steel  
Seals Viton

### SPECIFICATIONS

Max. operating pressure: 1500 psig  
HP models 3000 psig

Max. operating temperature: 400°F



# STAINLESS STEEL HIGH EFFICIENCY COALESCING FILTER - *continued* Series 7130 and 7140

## HOW TO ORDER

Model	Port Size	Drain Port	Dimensions (inches)			Filter Element P/N
			A	B	C	
7130-P4FF	1/4" NPTF	1/4" NPTF	0.59	2.52	5.16	25-64-xxx* or SS-130-xx*
7132-P8FF	1/2" NPTF	1/4" NPTF	0.59	2.52	5.16	25-64-xxx* or SS-130-xx*
7132HP-P8FF	1/2" NPTF	1/4" NPTF	0.59	2.95	5.16	25-64-xxx* or SS-130-xx*
7140-P4FF	1/4" NPTF	1/4" NPTF	0.59	2.52	9.69	25-178-xxx* or SS-140-xx*
7142-P8FF	1/2" NPTF	1/4" NPTF	0.59	2.52	9.69	25-178-xxx* or SS-140-xx*
7142HP-P8FF	1/2" NPTF	1/4" NPTF	0.59	2.95	9.69	25-178-xxx* or SS-140-xx*

\* Select element from table below.

Elements P/N	P/N
25-64-70K	SS-130-xx **
25-64-50K	SS-140-xx **
25-178-70K	** Select micron size desired
25-178-50K	

**Size Suffix	Micron Size
01	1
10	10
25	25
100	100

## AIR FLOW RATES IN SCFM AT 1.5 PSI PRESSURE DROP

### FILTER HOUSINGS USING ELEMENT SIZES 25-64 OR SS-130

Model	Element Grade		Air Pressure (psig)								
	Fluorocarbon	SS	1.5	15	30	60	100	150	250	1500	3000
7130 Series	50K, 50C	01	2.8	5.4	7.8	13	20	29	47	264	528
	70K, 70C	10	5.9	11	16	26	41	58	94	534	1070
		25/100	6.5	11	17	29	44	63	103	582	1160

### FILTER HOUSINGS USING ELEMENT SIZES 25-148 OR SS-140

Model	Element Grade		Air Pressure (psig)								
	Fluorocarbon	SS	1.5	15	30	60	100	150	250	1500	3000
7140 Series	50K, 50C	01	5.3	10	15	25	38	55	87	504	1008
	70K, 70C	10	7.1	13	19	32	48	69	112	636	1270
		25/100	7.7	14	21	35	53	78	125	708	1420

## IN-LINE FILTER Series 7500



In-line Filter - Series 7500

### FEATURES

- Compact in-line design with large filtration area
- Sintered 316 stainless steel element
- Choice of 1, 2, 5, 10, 50, or 100 micron filter element

### SPECIFICATIONS

Operating Pressure: Brass: 3000 psig  
 316 SS: 6000 psig\*  
 Operating Temp.: Brass: -30°F to 275°F  
 316 SS: -15°F to 400°F

### MATERIALS OF CONSTRUCTION

Model	Body	Seals	Filter Element
7510	brass	Buna-N	316 stainless steel
7520	316 SS	Viton	316 stainless steel

### HOW TO ORDER

Model	Inlet and Outlet Connections
7510-X-P4MM	1/4" NPT male x 1/4" NPT male
7510-X-P4FF	1/4" NPT female x 1/4" NPT female
7510-X-T4FF	1/4" compression x 1/4" compression
7510-X-P8MM	1/2" NPT male x 1/2" NPT male
7510-X-P8FF	1/2" NPT female x 1/2" NPT female
7520-X-P4MM	1/4" NPT male x 1/4" NPT male
7520-X-P4FF	1/4" NPT female x 1/4" NPT female
7520-X-T4FF	1/4" compression x 1/4" compression
7520-X-P8MM**	1/2" NPT male x 1/2" NPT male
7520-X-P8FF**	1/2" NPT female x 1/2" NPT female

Other end fitting configurations are available.

X - Specify filter element 1, 2, 5, 10, 50, or 100 microns.

\* 2 micron filter operating pressure is 3000 psig

\*\* 2 micron filter not available in 1/2" units

## GAS HEATERS Series 6284



### DESCRIPTION

The series 6284 gas heaters when installed between the cylinder and the regulator are designed to reduce the problem of regulator icing that is associated with high flow withdrawal rates of some gases due to their expansion from high pressure to low pressure.

This thermostatically controlled heater will not overheat the gas and can be left unattended without any gas flow. A pilot light indicates when the thermostat is closed and the heating element is operative.

### SPECIFICATIONS

Material: Steel case with black oxide finish covering a solid brass body  
 Max. flow: 90 cubic feet/hour  
 Voltage: 115 volt single phase 60 hz, 200 watts provided through a 5-foot grounded cord with molded plug.  
 Heating Range: Thermostat between 160° - 190°F. Outer case temperature 85°F  
 Dimensions: 6-5/8" overall length, 2-1/2" diameter.  
 Weight: 2 pounds

### HOW TO ORDER

Model	Application
6284-320	Carbon Dioxide
6284-326	Nitrous Oxide
6284-580	Argon

## **CYLINDER HEATING SYSTEM HB120 Series**

### **DESCRIPTION**

The HB-120 heater is an electrical appliance which supplies supplemental heat to replace the heat of evaporation normally lost when a liquefied gas changes state from liquid to gas inside steel cylinders. Freezing typically occurs with a change of state from liquid to gas is made at a rate faster than the liquid can absorb ambient heat. The use of a heater increases the speed at which the gas may be discharged from the cylinder.

The heater is designed to heat the lower part of the cylinder where freezing usually occurs. For larger flows the use of multiple heaters spaced over the length of the cylinder may be required.

The use of a single HB120 strap is ideal for preventing condensation of low volatility components in gas mixtures to help ensure that the mixture remains homogenous.

An insulating blanket is available to aid in ensuring that the heat is transferred into the cylinder and to aid in holding the heat on the cylinder.

Each heating belt is thermostatically controlled to 130°F to prevent overheating of the cylinder.

The heater has an adjustable Velcro® strap making it easy to apply band to cylinders with diameters of 8" to 10".

### **SPECIFICATIONS**

- 300 watt heating capacity
- Thermostatically controlled to 130°F
- Power – 120VAC/60Hz
- Dimensions – 27" long x 7" wide
- Weight less than 1 pound

### **HOW TO ORDER**

<b>Model Number</b>	<b>Description</b>
HB120	cylinder heater with 4' power cord and 130°F thermostat
HB120-BLK	insulating blanket 48" high x 36" wide

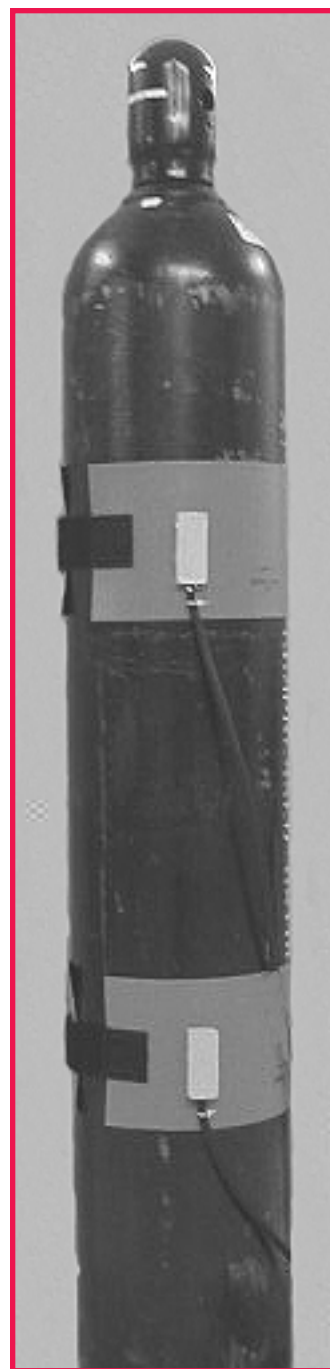

## **AUTOMATIC ELECTRIC GAS HEATERS** **For Compressed Gases Series 1000**

### **DESCRIPTION**

Many liquefied gases cool dramatically under even moderate flow conditions due to the heat of vaporization when the liquid is converted to gas. This effect causes "freezing" in pressure regulators and other equipment resulting in pressure and flow fluctuations. These thermostatically controlled heaters maintain a constant temperature within close limits regardless of load variations, thus assuring a uniform temperature and constant gas flow at all times. All units are completely automatic and can be left on indefinitely, even under no-flow conditions without damage.

### **APPLICATIONS**

- Welding Operations
- Hospitals/Anesthesiology
- Bottling Plants/Wineries
- Foundries
- Food Packaging
- Semiconductor
- Gas Freeze-up Applications

### **FEATURES:**

- Prevents regulator freeze-up
- Thermostatically controlled
- Double protection against thermal or electrical overload
- Continuous high pressure tubing –no internal joints
- Working pressures up to 4600 psig
- Completely dry - heat exchange medium is aluminum
- Heavily insulated - cabinet remains "cool"
- Can be left on, even under no-flow conditions
- Unlike ambient devices, not affected by adverse atmospheric conditions
- Flow can be in either direction, without loss of efficiency
- C.S.A. Approved
- One Year Guarantee on Material & Workmanship

### **SPECIFICATIONS**

- 11" high x 5.5" wide x 4.25" deep
- 5/16" x .049 continuous copper tubing
- 5/16" x .049 304 stainless tubing optional
- Working pressure: up to 2500 psig  
(stainless steel: 4600 psig)
- 11 lbs. actual weight; 13 lbs. shipping weight
- 6' 3-wire UL/CSA cord
- 120/240 volts A.C., single phase
- 8.3/4.2 amps (1000 watts)
- Mounting holes 3" on center



### **CAPACITY (FOR CARBON DIOXIDE, CO<sub>2</sub>)\*\***

- Heating : 1000 CFH; 17 CFM; 467 liters/minute; 115 lbs./hr. (Heating valves are based on initial gas temperature of 0°F and outlet temperature of 170°F)
- Vaporizing: 184CFH; 3 CFM; 84 liters/minute; 22 lbs./hr. (Vaporization valves are based upon initial liquid temperature of 0°F and outlet temperature of 170°F)

\*\*Capacities for other gases will vary, depending on their specific heat.

## ***AUTOMATIC ELECTRIC GAS HEATERS*** ***Continued***

### **HOW TO ORDER**

#### **1. Select basic model**

<b>Model</b>	<b>Number Description</b>
1000	1000 watts, 120 volts A.C., copper tubes
SS1000	1000 watts, 120 volts A.C., stainless steel tubes

#### **2. Select fittings (add to end of basic model #)**

<b>Fittings</b>	<b>Suffix Description</b>
-320	CGA 320 female x male (Carbon Dioxide, CO <sub>2</sub> )
-326	CGA 326 female x male (Nitrous Oxide, N <sub>2</sub> O)
-580	CGA 580 male x female (Nitrogen, N <sub>2</sub> )
-4	1/4" NPT male x male (brass)
-4SS	1/4" NPT male x male (stainless)

(Other fittings available on request)



## **ELECTRONIC CYLINDER SCALES FOR LIQUEFIED AND CRYOGENIC GASES**

### **FEATURES**

- Controller has large 1" high LCD digital display in water resistant housing
- Rugged load cell weighing technology with 300, 500, or 1000 pound capacity
- Weight resolution up to 0.1 pound
- Accuracy 0.1% of full scale
- Built-in visual alarm and audible alarm with silence function
- Built-in solid state relay
- 0-100% of full scale tare weight adjustment
- 0-100% of full scale alarm set point adjustment
- Both large and small platform sizes available
- Easy unit conversion from pounds to kilograms

### **DESCRIPTION**

The pressure of a liquefied gas remains constant as material is withdrawn as long as a liquid phase remains in the cylinder. When the liquid phase is exhausted the pressure drops very quickly and the cylinder empties without warning. This phenomenon renders a cylinder pressure gauge virtually useless. A similar situation arises when using cryogenic containers of liquid nitrogen, oxygen, and argon. The only way to monitor the contents of a cylinder of liquefied gas or a cryogenic container is by weight.

The Series 620 and 320 electronic scales are designed to give a positive indication of the amount of product remaining in the cylinder as material is being withdrawn. These units allow the user to electronically subtract the tare weight of the cylinder so that only the net contents can be read directly. The built-in alarm can be set for any weight value from 0-100% of the scales capacity. The units provide a red LED visual alarm and an audible alarm with silence function. An integral solid state relay is provided for the activation of external alarms or other equipment when the alarm set point is reached.

The scales are ruggedly constructed using one or more load cells in a sturdy stainless steel and/or aluminum diamond plate platform with mechanical stops at 150% of



320 Series



620G-300

capacity to prevent damage.

The model 620G-300 with a capacity of 300 pounds has a 9.5" x 9.5" stainless steel platform that accommodates most compressed gas cylinders. For larger diameter cylinders, the 320D-500 is available with a capacity of 500 pounds has a 20" x 27" diamond plate steel platform. The model 320M-1000 has a 1000 pound capacity and accommodates cryogenic containers with its 20" x 27" aluminum diamond plate steel platform. A ramp is available for each model so that cylinders can easily be rolled on and of the scale platform without lifting.

### **APPLICATIONS**

Recommended for use with all liquefied and cryogenic containers in applications where running out of gas will cause a serious disruption in operations or a loss of product.

### **HOW TO ORDER**

<b>Model</b>	<b>Total Capacity Pounds</b>	<b>Resolution pounds</b>	<b>Platform Dimensions</b>
620G-300	300	0.1	9.25" w x 9.25" d x 1.5" h
320D-500	500	0.1	20" w x 27" d x 1-7/8" h
320M-1000	1000	0.2	20" w x 27" d x 1-7/8" h
620R	ramp for 620G		9" w x 5.5" d x 1.5" h
320R	ramp for 320D & 320M		20" w x 18" d x 1-7/8" h

## **CYLINDER SCALE FOR LIQUEFIED GASES**

### **Model 900**

#### **FEATURES**

- Heavy duty 16 gauge
- Stainless steel cover
- Dual dial scale - pounds and kilograms
- Color-coded easy to read dial

#### **DESCRIPTION**

The pressure of a liquefied gas remains constant as material is withdrawn as long as a liquid phase remains in the cylinder. When the liquid phase is exhausted the pressure drops very quickly and empties without warning. This phenomenon renders a cylinder pressure gauge virtually useless. The only way to monitor the contents of a cylinder containing a liquefied gas is by weight.

The Model 900 cylinder scale is designed to give a positive indication of the amount of product remaining in the cylinder. It allows the user to subtract the tare weight of the cylinder so that the net contents can be read directly. A color coded dial reads in pounds and kilograms. A non-skid ramp is available to make loading cylinders convenient and easy.

The scale is ruggedly constructed and features a stainless steel cover for durability.

#### **APPLICATIONS**

Recommended for use with all liquefied gases such as carbon dioxide, ammonia, nitrous oxide, fluorocarbons, hydrogen sulfide, sulfur dioxide, propane and heavier hydrocarbon gases.

#### **SPECIFICATIONS**

Tare weight range: 0-150 lbs.(0-68 kg.)

Product weight range: 0-150 lbs.(0-68 kg.)

Total capacity: 300 lbs(136 kg.)

in 5 lb.(2 kg.) divisions.

Readability: 1 lb.(0.5 kg.) by estimation

Dimensions: 10 3/4" x 10 1/4" x 2" high

#### **HOW TO ORDER**

<b>Model</b>	<b>Description</b>
900	Scale with non-skid ramp
900-5	Scale only
900-6	Ramp only

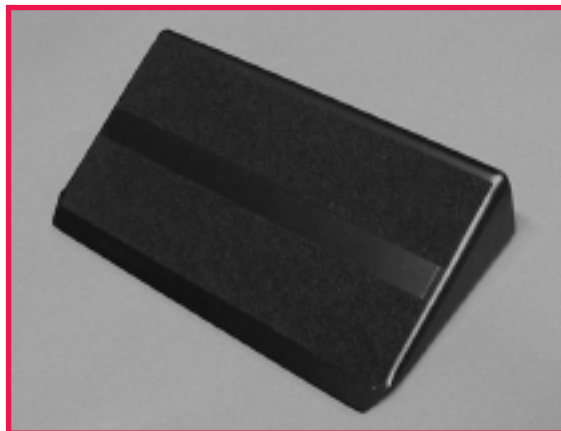

900-6 Scale Ramp

# FLASH ARRESTOR SERIES 8491

## DESCRIPTION

The new 8491 Series re-settable flashback arrestors offer four (4) safety devices in each unit. Safety features include protection against flashbacks with a wide range of mixtures of oxygen or air with flammable gases including hydrogen, acetylene, methane, and LPG gases. The design includes a built-in non-return (check) valve to stop reverse flow and a thermal shut off which stops gas flow in the event of a hose or pipe line fire. An easily re-settable pressure control stops gas flow in the event of reverse flow or a flashback that creates 10 psig back pressure. This feature alerts the user that a reverse flow or a flashback of greater than 10 psig has occurred. These units are easily re-set by pulling up on the pressure control ring (shown at right), no disassembly of the gas line or special tools are needed. The 8491 Series high flow capacity makes them suitable for a broad range of applications (see flow table). Units are U/L listed and meet ISO 5175, EN 730, BS 6158, and AS 4603 standards.



## FEATURES

- 100% flashback tested after assembly
- U/L listed and meets strict international standards
  - Working Pressures:
    - Acetylene @ 15.0 psig
    - Hydrogen/oxygen @ 50.0 psig
    - Hydrogen/air @ 150.0 psig
    - LPG @ 50.0 psig
    - Oxygen @ 143.0 psig
- Automatically re-sets for flashbacks and reverse flow below 10 psig
- Alerts user by shutting off gas flow in the event of a reverse flow or flashback exceeding 10 psig back pressure (captures back pressure in the housing, no flame or gas is exhausted to the atmosphere)
- Stainless steel flame barrier positively extinguishes flame within the housing.
- Checks reverse flow and provides positive shut-off of reverse flow over 10 psig.
- Thermal cut-off
- Built-in 100 micron stainless steel sintered filter on inlet.
- High flow capacity (see table)

## MATERIALS OF CONSTRUCTION

Body: Alloy 360 brass  
 Internals: brass  
 Flame barrier: stainless steel  
 Elastomers: Neoprene

## WORKING PRESSURE (U/L)

Gas	Pressure PSIG
Acetylene	15.0
Hydrogen/oxygen	50.0
Hydrogen/air	150.0
Methane/LPG	50.0
Oxygen	143.0

## FLOW PERFORMANCE

Inlet Press. PSIG	Air Flow SCFH
7.3	231.0
14.5	465.0
21.8	725.0
36.3	1041.0
72.5	1933.0

## HOW TO ORDER

Model	Gas Service	Connections	
		Inlet	Outlet
8491-F	flammables	1/4" NPT female	1/4" NPT female
8491-O	oxidizers	1/4" NPT female	1/4" NPT female
8491-FL	flammables	9/16-18 LH female	9/16-18 LH male
8491-OR	oxidizers	9/16-18 RH female	9/16-18 RH male

## MANIFOLD TUTORIAL

Manifolds are used to connect two or more cylinders of gas together to increase the supply volume available to provide a continuous flow when one cylinder is not sufficient and a tube trailer or other bulk supply is not practical. Manifolds are also used when a single cylinder of gas is not capable of supplying the required flow rate required by a process.

**WARNING: Never mix gases on a manifold. Only one type of gas should be connected to a manifold.**

Manifolds are commonly fabricated in a single row configuration designed for wall mounting with a row of cylinders in line beneath or in front of it. Double row manifolds and other custom configurations are available on request.

**Station valves** are used to isolate individual cylinders on a manifold from service. Station valves are recommended for most laboratory applications as they are a valuable back-up device in the event of a leaking pigtail or a defective check valve. It is most important that station valves used in high purity gas service be of the diaphragm packless type to maintain gas purity. Many commercial manifolds use packed valves that may cause atmospheric impurities to enter the gas stream as contaminants.

Two types of **pigtails** are used to connect cylinders to the manifold header; rigid pigtails made of brass or stainless steel tubing, or flexible made of stainless steel braided hose with either Teflon-lining or stainless steel inner core. Teflon-lined pigtails are used for routine applications, while the stainless steel inner core pigtails are used for ultra high purity applications. One special note, either rigid pigtails or stainless steel inner core flexible pigtails are recommended for helium and hydrogen because these gases will diffuse through the wall of a Teflon-lined pigtail.

**Check valves** on the cylinder end of each pigtail should always be installed on manifolds used for flammable, toxic,

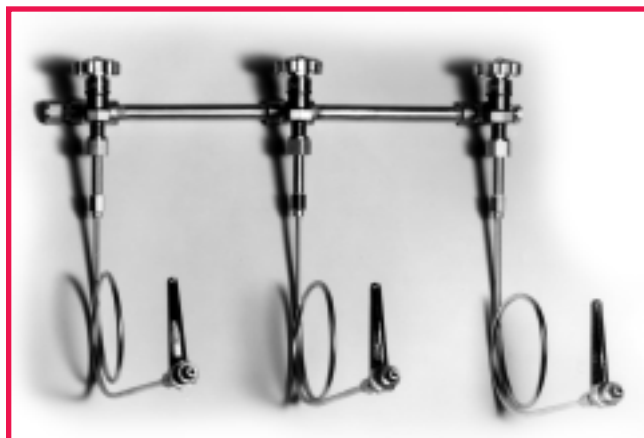

or corrosive gases. In some cases purge assemblies are installed to ensure that highly toxic gases are not released to the working environment during cylinder change outs.

Many applications require that gas always be supplied to the process and the flow can not be shut down to replace empty cylinders or must feed gas for long periods when the system is unattended, i.e. helium to a gas chromatography laboratory. In these instances a changeover manifold is the solution. Changeover manifold control sections available in this catalog (see pages 70-73, and 76) can be used with any of the multiple station manifolds or with a single pigtail on each side.

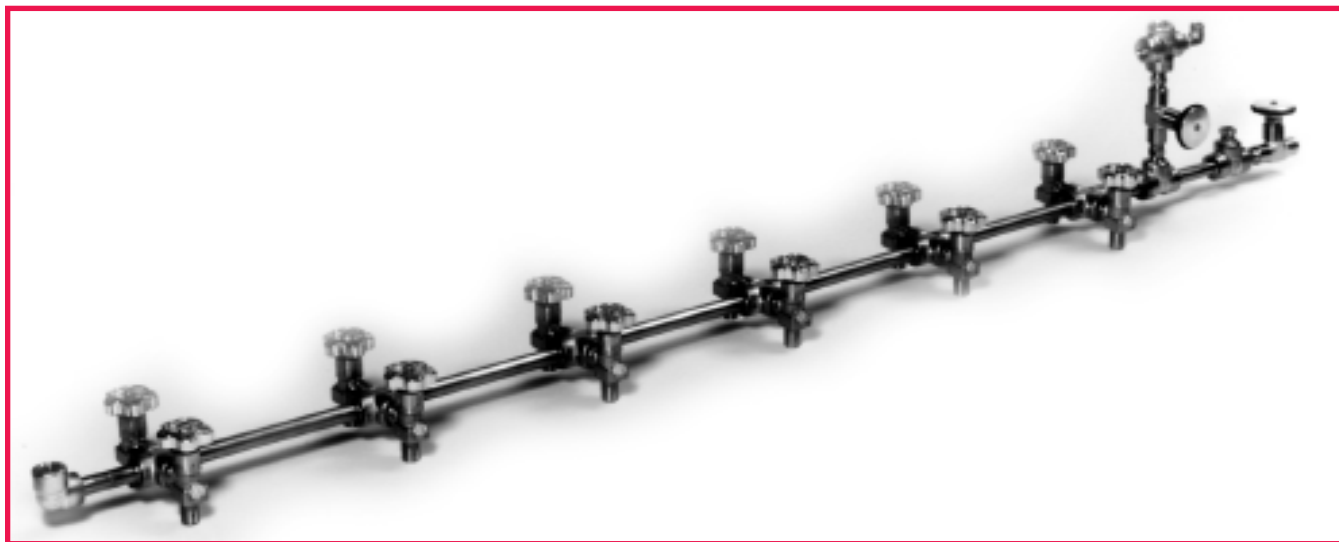

## BRASS MANIFOLDS

### FEATURES:

- Diaphragm packless station valves for high purity
- 3000 psig service pressure
- Cleaned for high purity service
- Standard CGA 346 header pigtail connections

### DESCRIPTION

These manifolds are constructed of 1/2" brass pipe and fittings screwed together then silver-brazed at each joint. Station valves are the diaphragm packless type for high purity service and are installed with Teflon tape so that they may be easily replaced in the field if necessary. All header pigtail connections are CGA 346 to help ensure that pigtails are installed properly. A plug is inserted in the last tee to allow for the addition of future cylinder stations if required. Suitable brackets for mounting the manifold to a wall are provided.

### SPECIFICATIONS

Materials:  
Header and Valves: brass  
Pigtails: 24" rigid type brass with brass CGA connections.

Check valves: brass  
Pressure rating: 3000 psig  
Header outlet: mating connection to pigtail cylinder CGA

### HOW TO ORDER

Model	Description
910-1-X-CGA*	single row manifold without station valves, but with check valves in the pigtails
910-2-X-CGA*	single row manifold with station valves, but no check valves in pigtails
910-3-X-CGA*	single row manifold with station valves and check valves in the pigtails.
920-1-X-CGA*	double row manifold without station valves, but with check valves in the pigtails
920-2-X-CGA*	double row manifold with station valves, but no check valves in pigtails
920-3-X-CGA*	double row manifold with station valves and check valves in the pigtails.

\* Complete the model number by inserting the number of cylinders to be connected to the manifold in place of the X and specifying the CGA connection.

### OPTIONS

Flexible pigtails -  
for Teflon-lined add suffix FP601B-Y  
for stainless steel inner core add suffix FP604B-Y  
Y = pigtail length in feet

Outlet connection - 1/2" NPT female - add suffix "P8F"

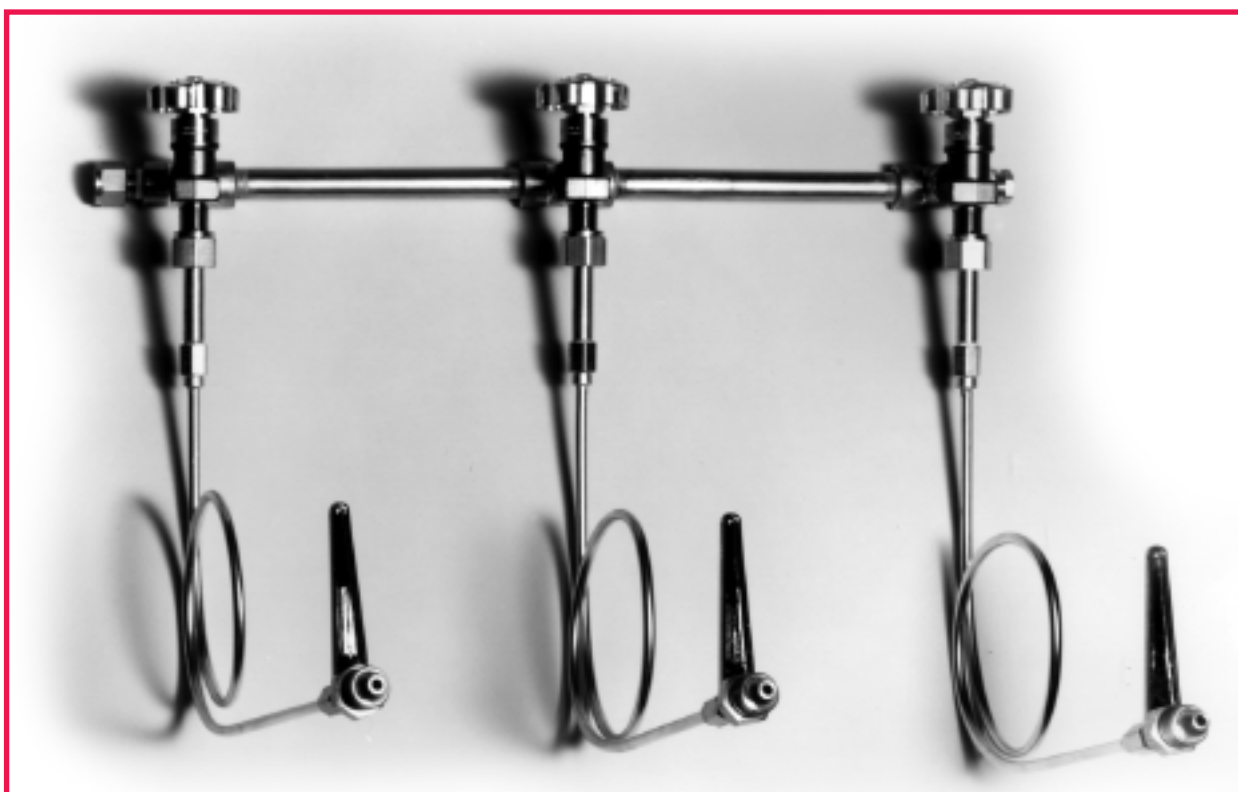

## STAINLESS STEEL MANIFOLDS

### FEATURES:

- Diaphragm packless station valves for high purity
- 3000 psig service pressure(4500 and 6000 psig available)
- Cleaned for high purity service
- Standard CGA 346 header pigtail connections

### DESCRIPTION

These manifolds are constructed of 1/2" 316 stainless steel pipe and fittings screwed together then heliarc welded at each joint. Station valves are the diaphragm packless type for high purity service and are installed with Teflon tape so that they may be easily replaced in the field if necessary. All header pigtail connections are CGA 346 to help ensure that pigtails are installed properly. A plug is inserted in the last tee to allow for the addition of future cylinder stations if required. Suitable brackets for mounting the manifold to a wall are provided.

### SPECIFICATIONS

Materials:

Header and Valves: 316 stainless steel  
Pigtails: 24" rigid type 316 stainless steel w/ stainless steel CGA connections.

Check valves: 316 stainless steel  
Pressure rating: 3000 psig  
Header outlet: mating connection to pigtail cylinder CGA

### HOW TO ORDER

Model	Description
911W-1-X-CGA*	single row manifold without station valves, but with check valves in the pigtails
911W-2-X-CGA*	single row manifold with station valves, but no check valves in pigtails
911W-3-X-CGA*	single row manifold with station valves and check valves in the pigtails.
921W-1-X-CGA*	double row manifold without station valves, but with check valves in the pigtails
921W-2-X-CGA*	double row manifold with station valves, but no check valves in pigtails
921W-3-X-CGA*	double row manifold with station valves and check valves in the pigtails.

\* Complete the model number by inserting the number of cylinders to be connected to the manifold in place of the X and specifying the CGA connection.

### OPTIONS

Flexible pigtails -

for stainless steel inner core add suffix FP604-Y

Y = pigtail length in feet

Outlet connection - 1/2" NPT female - add suffix "P8F"

Manifolds for 4500 or 6000 psig service are also available.

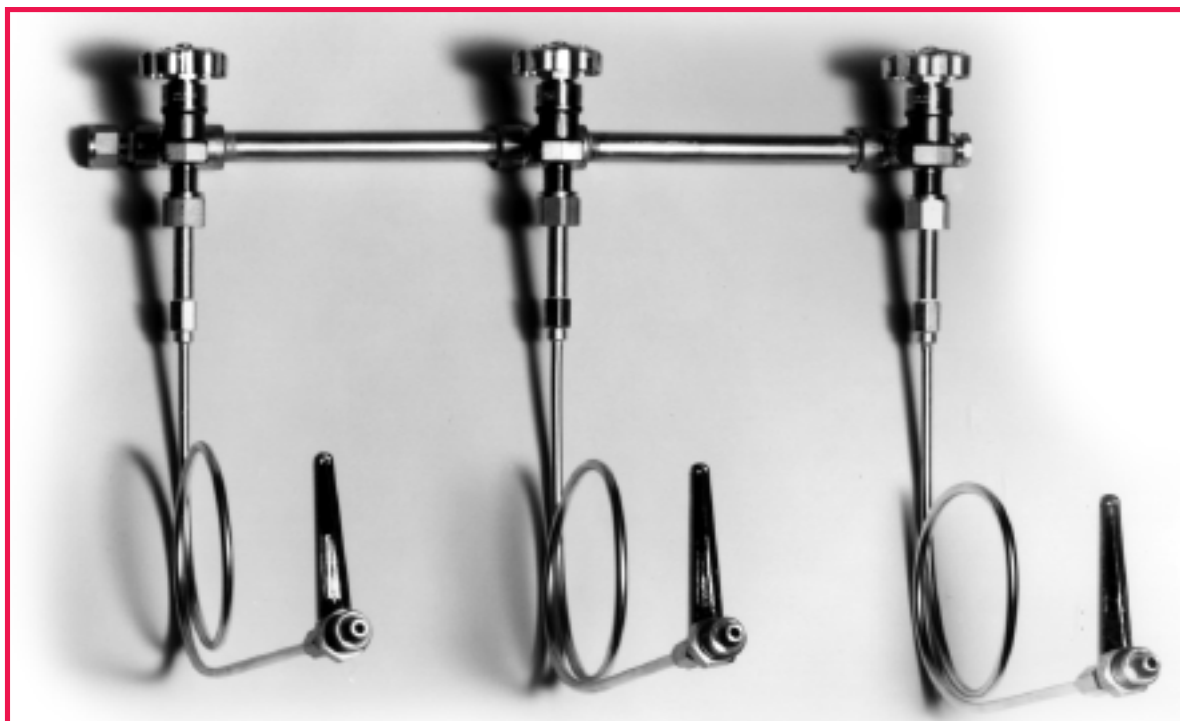

# **AUTO-LOGIC™ FULLY AUTOMATIC ELECTRONIC CHANGEOVER MANIFOLD**

## **Series 918E**

### **DESCRIPTION**

The electronically operated **AUTO-LOGIC** 918E Series changeover manifolds are truly fully automatic. Once you have set the operating parameters, you need only change cylinders as necessary. The system takes care of everything else. There is no need to make pressure adjustments or flip a knob after the system has switched from one side to the other. Just replace the empty cylinders and open the valves. The system is now set to change in the opposite direction. These systems are truly automatic and hassle free.

**One system does it all.** The 918E Series is extremely versatile. It can be used with high pressure cylinders on both sides, with liquid containers on one side and high pressure cylinders on the other side, or with liquid containers on both sides. You decide. If your needs change, just reset the operating parameters to reflect your current requirements and you are ready to go. The system can be used with any gas source on either side – single gas containers, liquid containers, manifolds, six or twelve packs, tube trailers, etc.

The 918E is available constructed with brass or stainless steel high purity gas components. It has digital pressure readouts for inlet pressures and outlet delivery pressure, built-in alarms, and relay contacts to operate external equipment, such as remote alarms or an auto-dialer. Entire system is housed in a NEMA 4X box.

### **FEATURES**

- Fully automatic, simple, hassle free operation
- Fully programmable, user friendly touch pad controls
- Built-in computerized controller
- No variance in delivery pressure
- Designed for high purity gas service
- May be used with any gas source
- Digital pressure readouts
- Built-in audio and visual alarm
- System housed in a NEMA 4X box
- External dry contacts for remote alarm

### **SPECIFICATIONS**

Max inlet pressure:	3000 psig
Power required:	120 VAC/60Hz
Cv	0.07 (0.24 optional)
Inlet and outlet connections:	1/4" NPT female



---

# **AUTO-LOGIC™ FULLY AUTOMATIC ELECTRONIC CHANGEOVER MANIFOLD - continued Series 918E**

## **HOW TO ORDER**

<b>Model</b>	<b>Description</b>	<b>Delivery Pressure</b>
918E-1-250	brass electronic high purity changeover manifold	0-250 psig
918E-2-250	stainless steel electronic high purity changeover manifold	0-250 psig

### **Options**

912-AVA audio/visual alarm module for remote alarm

---

### **Pigtails for 918E Changeover Manifolds (2 per set)**

#### **For Brass Manifolds**

918-RPB-CGA\* two rigid brass pigtailed without check valves  
918-RPB-CV-CGA\* two rigid brass pigtailed with check valves  
918-FP601-Y-CGA\* two flexible Teflon lined stainless steel braided pigtailed with brass fittings and no check valves  
918-FP601-Y-CV-CGA\* two flexible Teflon lined stainless steel braided pigtailed with brass fittings and check valves  
918-FP604B-Y-CGA\* two flexible all stainless steel braided pigtailed with brass fittings and no check valves  
918-FP604B-Y-CV-CGA\* two flexible all stainless steel braided pigtailed with brass fittings and check valves

#### **For Stainless Steel Manifolds**

918-RPS-CGA\* two rigid brass pigtailed without check valves  
918-RPS-CV-CGA\* two rigid brass pigtailed with check valves  
918-FP604-Y-CGA\* two flexible all stainless steel braided pigtailed without check valves  
918-FP604-Y-CV-CGA\* two flexible all stainless steel braided pigtailed with check valves

\* Specify CGA connection when ordering

Y = pigtail length in feet

# HIGH PURITY SEMI-AUTOMATIC CHANGEOVER MANIFOLD Series 914

## DESCRIPTION

The Series 914 semi-automatic changeover manifold is another solution for providing an uninterrupted supply of gas to your instrumentation or process. It incorporates a specially machined two-regulator in one body that simplifies changeover operation and reduces the wall space required. The feed and line regulators are of high purity construction with stainless diaphragms and diffusion resistant construction capable of passing a helium leak rate test of  $1 \times 10^{-9}$ .

Available in both brass and 316SS construction, the 914 Series is provided complete with changeover regulator and line regulator installed on a mounting bracket for easy installation. **Pigtails and/or manifold sections are ordered separately.**

The manifold is assembled using the 914 central control section shown on this page and two manifold sections from pages 58 and 59 or a pigtail set from the list below to provide the supply banks. A simple two station semi-automatic manifold commonly used to ensure a continuous supply of carrier gas to a gas chromatograph employs a central control section with a pigtail installed on both inlets.

## SPECIFICATIONS

Max. inlet pressure	3000 psig
Inlet and Outlet ports	1/4" NPT female
C <sub>v</sub>	0.07 standard (0.24 optional)**
Operating temperature	-40° to +165°F
Weight	7.75 lbs.



914 AVA

## HOW TO ORDER

Model**	Description
<b>Brass Central Control Section</b> (header only - no pigtails)	
914-1-025	line regulator delivery range 0-25 psig
914-1-050	line regulator delivery range 0-50 psig
914-1-100	line regulator delivery range 0-100 psig
914-1-150	line regulator delivery range 0-150 psig
<b>Stainless Steel Central Control Section</b> (header only - no pigtails)	
914-2-025	line regulator delivery range 0-25 psig
914-2-050	line regulator delivery range 0-50 psig
914-2-100	line regulator delivery range 0-100 psig
914-2-150	line regulator delivery range 0-150 psig
<b>Optional Accessories</b>	
914-3B	Brass Pressure Switches (one each side)
914-3S	Stainless Steel Pressure Switch (one each side)
914-AVA	Audio/visual alarm system

\*\*Add "HF" to base part number for high flow unit

### Pigtails Sets for Brass Changeover Manifolds (2 per set)

914-RPB-CGA*	two rigid brass pigtails without check valve
914-RPB-CV-CGA*	two rigid brass pigtails with check valve
914-FP601-Y-CGA*	two flexible Teflon-lined stainless steel braided pigtails with brass fittings and no check valve
914-FP601-Y-CV-CGA*	two flexible Teflon-lined stainless steel braided pigtails with brass fittings and check valve
914-FP604B-Y-CGA*	two flexible all stainless steel braided pigtails with brass fittings and no check valve
914-FP604B-Y-CV-CGA*	two flexible all stainless steel braided pigtails with brass fittings and check valve

### Pigtails Sets for Stainless Steel Changeover Manifolds (2 per set)

914-RPS-CGA*	two rigid stainless steel pigtails without check valve
914-RPS-CV-CGA*	two rigid stainless steel pigtails with check valve
914-FP604B-Y-CGA*	two flexible all stainless steel braided pigtails without check valve
914-FP604B-Y-CV-CGA*	two flexible all stainless steel braided pigtails with check valve

\*Specify CGA connection when ordering

Y = pigtail length in feet

# ECONOMICAL HIGH PURITY SEMI-AUTOMATIC CHANGEOVER MANIFOLD

## Series 916

The 916 Series semi-automatic changeover manifold provides a lower cost solution for providing an uninterrupted gas supply to your instrumentation or process. Available in brass or 316 stainless steel, the 916 Series offers the convenience of a simple flip knob to readjust pressures after a changeover and a line regulator to ensure a constant delivery pressure to your system.

A pressure switch alarm assembly is available to notify the user that a changeover has taken place, the manifold needs to be set to switch the other way, and the empty cylinders should be changed.

The system can simply be used with one pigtail on each side, or connected to larger manifolds such as those shown on pages 58 and 59. Pigtails and/or manifolds sections are ordered separately.

### SPECIFICATIONS

Max. Operating Press.	3000 psig
Inlet and outlet ports:	1/4" NPT female
Operating Temperature:	-40°F to +165°F
Flow coefficient Cv	0.07 (0.24 optional)**



916

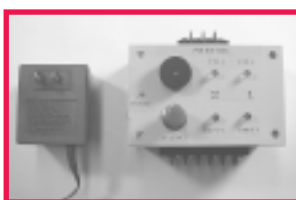

914 AVA

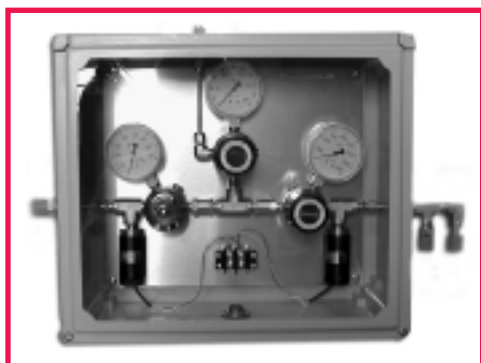

916 BX

### HOW TO ORDER

Model	Description
<b>Brass Central Control Section</b>	
(Control section only – no pigtails)	

916-1-025	line regulator delivery range 0-25 psig
916-1-050	line regulator delivery range 0-50 psig
916-1-100	line regulator delivery range 0-100 psig

<b>Stainless Steel Central Control Section</b>	
(Control section only – no pigtails)	
916-2-025	line regulator delivery range 0-25 psig
916-2-050	line regulator delivery range 0-50 psig
916-2-100	line regulator delivery range 0-100 psig

916-2-025	line regulator delivery range 0-25 psig
916-2-050	line regulator delivery range 0-50 psig
916-2-100	line regulator delivery range 0-100 psig

\*\*For optional 0.24 Cv high flow manifold add "HF" to part number, for example, 916HF-1-050

### Options

916-3B brass pressure switch alarm assembly (one each side)  
 916-4S stainless steel pressure switch alarm assembly (one each side)  
 914-AVA audio/visual alarm module  
 Manifold mounted in a NEMA4 box – add "BX" to part number, for example, 916BX-1-050

### Pigtails for Brass Manifolds

916-RPB-CGA*	rigid brass pigtail without check valve
916-RPB-CV-CGA*	rigid brass pigtail with check valve
916-FP601-Y-CGA*	flexible Teflon-lined stainless steel braided pigtail with brass fittings and no check valve
916-FP601-Y-CV-CGA*	flexible Teflon-lined stainless steel braided pigtail with brass fittings and check valve
916-FP604B-Y-CGA*	flexible all stainless steel braided pigtail with brass fittings and no check valve
916-FP604B-Y-CV-CGA*	flexible all stainless steel braided pigtail with brass fittings and check valve

### Pigtails for Stainless Steel Manifolds

916-RPS-CGA*	rigid stainless steel pigtail without check valve
916-RPS-CV-CGA*	rigid stainless steel pigtail with check valve
916-FP604B-Y-CGA*	flexible all stainless steel braided pigtail without check valve
916-FP604B-Y-CV-CGA*	flexible all stainless steel braided pigtail with check valve

\*Specify CGA connection when ordering  
 Y = pigtail length in feet

## PROTOCOL STATIONS

### Series 917

#### DESCRIPTION

The 917 protocol station is designed to provide a convenient way to mount virtually any pressure regulator that has a CGA connection or 1/4" NPT female inlet. The wall mounting of a regulator makes changing cylinders safer and hassle-free, while protecting the regulator from damage during the changing process because the operator handles only the flexible pigtail.

The 917 series is available in brass or 316 stainless steel in both single cylinder and double cylinder configurations. Pressure regulators are connected to the system with regular CGA cylinder connections rather than be rigidly mounted;

this mounting system provides the virtual universality of the 917 and makes changing a regulator easy should it need to be replaced for any reason. A pressure switch alarm option is available to alert users that the cylinder in use is approaching empty. When check valves are selected they are integral with the CGA connection to the cylinder. All models are rated for 3000 psig operating pressure.

The 917H protocol station is designed for use with helium and hydrogen and mixtures containing them. This model maintains the economy of the brass unit, but replaces the Teflon-lined pigtail with an all stainless steel pigtail to eliminate the diffusion of these small molecule gases through the Teflon lining.

#### MATERIALS OF CONSTRUCTION

	<b>917B</b>	<b>917H</b>	<b>917S</b>
Bracket:	stainless steel	stainless steel	stainless steel
Manifold block:	brass	brass	stainless steel
Flexible hose:	Teflon-lined w/SS braid	All stainless steel	All stainless steel
CGA connections:	brass	brass	stainless steel
Check valves:	brass with buna-N seals	brass with buna-N seals	SS with Viton seals
Valves:	brass diaphragm type	brass diaphragm type	SS diaphragm type



Regulator is not included and should be ordered separately.

## **PROTOCOL STATIONS - Continued**

### **Series 917**

#### **HOW TO ORDER**

<b>Model*</b>	<b>Description</b>
917B-2-CGA	protocol station w/brass fittings and 2' pigtail
917B-3-CGA	protocol station w/brass fittings and 3' pigtail
917B-2-CV-CGA	protocol station w/brass fittings, 2' pigtail w/check valve
917B-3-CV-CGA	protocol station w/brass fittings, 3' pigtail w/check valve
917BV-2-CGA	protocol station w/brass fittings, isolation valve, and 2' pigtail
917BV-3-CGA	protocol station w/brass fittings, isolation valve, and 3' pigtail
917BV-2-CV-CGA	protocol station w/brass fittings, isolation valve, and 2' pigtail w/ check valve
917BV-3-CV-CGA	protocol station w/brass fittings, isolation valve, and 3' pigtail w/ check valve
917H-2-CGA	protocol station w/brass fittings and 2' stainless steel pigtail
917H-3-CGA	protocol station w/brass fittings and 3' stainless steel pigtail
917H-2-CV-CGA	protocol station w/brass fittings, 2' stainless steel pigtail w/check valve
917H-3-CV-CGA	protocol station w/brass fittings, 3' stainless steel pigtail w/check valve
917HV-2-CGA	protocol station w/brass fittings, isolation valve, and 2' stainless steel pigtail
917HV-3-CGA	protocol station w/brass fittings, isolation valve, and 3' stainless steel pigtail
917HV-2-CV-CGA	protocol station w/brass fittings, isolation valve, and 2' stainless steel pigtail w/ check valve
917HV-3-CV-CGA	protocol station w/brass fittings, isolation valve, and 3' stainless steel pigtail w/ check valve
917S-2-CGA	protocol station w/stainless steel fittings and 2' pigtail
917S-3-CGA	protocol station w/stainless steel fittings and 3' pigtail
917S-2-CV-CGA	protocol station w/stainless steel fittings, 2' pigtail w/check valve
917S-3-CV-CGA	protocol station w/stainless steel fittings, 3' pigtail w/check valve
917SV-2-CGA	protocol station w/stainless steel fittings, isolation valve, and 2' pigtail
917SV-3-CGA	protocol station w/stainless steel fittings, isolation valve, and 3' pigtail
917SV-2-CV-CGA	protocol station w/stainless steel fittings, isolation valve, and 2' pigtail w/ check valve
917SV-3-CV-CGA	protocol station w/stainless steel fittings, isolation valve, and 3' pigtail w/ check valve

\*Specify CGA connection when ordering. For dual cylinder units add prefix "D" to the model number, i.e. D917S-2-CV-660

#### **Options**

P/N 4610-P4FF brass tee purge assembly

P/N 4620-P4FF stainless steel tee purge assembly

P/N 917S-XXX Pressure switch alarm assembly (XXX – specify pressure setting desired)

P/N 912-AVA audio visual alarm module

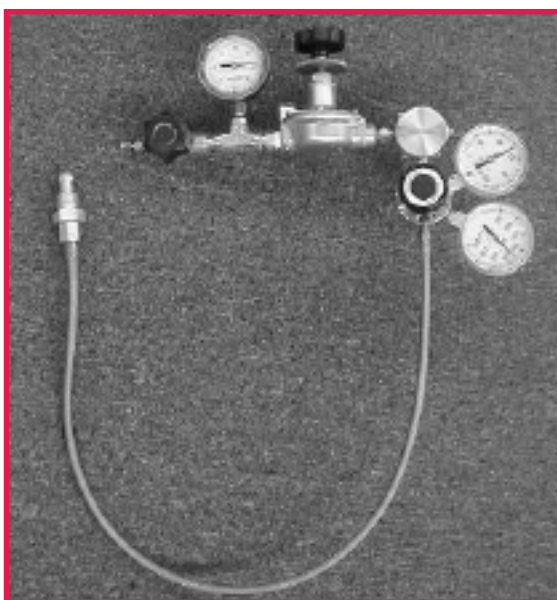

SP22346 demonstrates an interesting use of a 917 protocol station with the 3101HY2701.

# HIGH PURITY SEMI-AUTOMATIC CHANGEOVER MANIFOLD Model 912

## DESCRIPTION

The semi-automatic changeover manifold is an economic solution for providing an uninterrupted supply of gas to your instrumentation or process. The feed and line regulators and the interconnecting valves are of high purity, metal diaphragm, diffusion resistant construction capable of passing a helium leak rate test of  $1 \times 10^{-9}$ .

The manifold is assembled using the central control section shown on this page and a manifolded bank of cylinders on each side or other bulk source to provide a gas supply. A simple two station semi-automatic manifold commonly used to ensure a continuous supply of carrier gas to a gas chromatograph employs a central control section with a pigtail installed on each of the regulator inlets. **Pigtails and/or manifold sections are ordered separately.** See pages 58 and 59 for manifolds.

The operation is simple. The left and right regulators on the control section are set at slightly different discharge pressures between 100 -250 psig, so that they discharge only one bank at a time. The line regulator in the center is set at the desired delivery pressure to your system. When the switch-over occurs, and bank #2 is feeding, the first bank of empty cylinders can be replaced. The pressure settings on the regulators are then reversed. When bank #2 is empty, the manifold will automatically switch back to bank #1. The line regulator ensures that a constant delivery pressure

and flow is maintained on the common discharge line.

## HOW TO ORDER

Model	Description
<b>Brass Central Control Section</b> (header only - no pigtails)	
912-1-025	line regulator delivery range 0-25 psig
912-1-050	line regulator delivery range 0-50 psig
912-1-100	line regulator delivery range 0-100 psig
<b>Stainless Steel Central Control Section</b> (header only - no pigtails)	
912-2-025	line regulator delivery range 0-25 psig
912-2-050	line regulator delivery range 0-50 psig
912-2-100	line regulator delivery range 0-100 psig
<b>Options</b>	
912-3B	Brass Pressure Switch(installed)
912-3S	Stainless Steel Pressure Switch(installed)
912-AVA	audio/visual alarm for use with pressure switch
<b>Pigtails</b> (set of 2)	
<b>For brass units</b>	
912-RPB-Y-CGA*	rigid brass without check valve
912-RPB-Y-CV-CGA*	rigid brass with check valve
912-FP601-Y-CGA*	flexible Teflon-lined w/brass fittings, without check valve
912-FP601-Y-CV-CGA*	flexible Teflon-lined with brass fittings and check valve
912-FPB604-Y-CGA*	flexible SS inner core with brass fittings, without check valve
912-FPB604-Y-CV-CGA*	flexible SS inner core with brass fittings and check valve
<b>For stainless steel units</b>	
912-RPS-Y-CGA*	rigid SS without check valve
912-RPS-Y-CV-CGA*	rigid SS with check valve
912-FP604-Y-CGA*	flexible SS inner core with SS fittings, without check valve
912-FP604-Y-CV-CGA*	flexible SS inner core with SS fittings and check valve

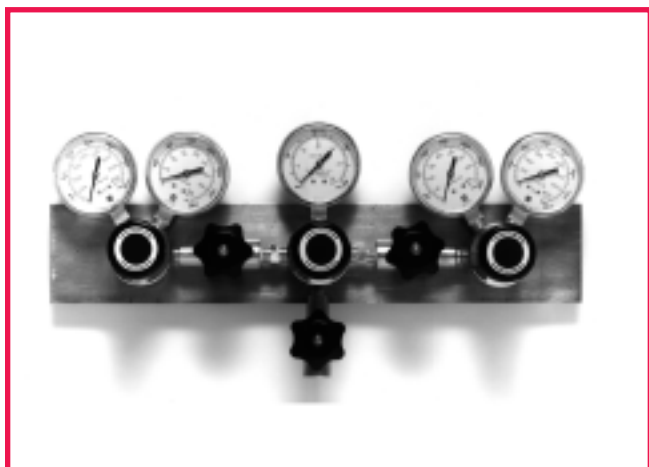

912 AVA

\*Specify CGA connection when ordering  
 Y = pigtail length in feet

## LOW GAS PRESSURE ALARM Series 9900

### DESCRIPTION

The Series 9900 complies with the requirements of NFPA 99 2002 paragraph 5.1.10.5.5 that mandates the continuous monitoring of purge gas while welding or brazing gas lines.

These alarms are ideal for any gas application where a decrease in gas pressure could be detrimental to the operation.

Rated for 3000 psig the Series 9900 can be installed between the cylinder valve and the user's pressure regulator or system. At low pressure, the Series 9900 provides both an audible and visual alert to the user when the container pressure reaches the pre-set level. Units are available in brass or stainless steel with the appropriate CGA connections for easy installation between an existing cylinder and regulator, or with pipe threads or compression fittings for permanent installation into a gas supply system.

Standard models require 110 VAC power. For remote locations or where power is not readily available there are battery-powered models that operate on a standard 9V battery.

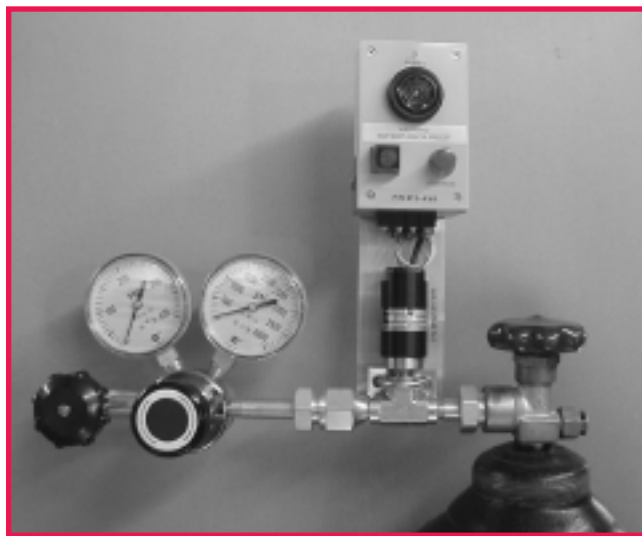

Regulator sold separately.

### FEATURES

- Wide range of alarm pressure selection
- Available in brass or stainless steel
- Available with CGA connections or 1/4" NPT female inlet and outlet
- Complies with the requirements of NFPA 99 2002 paragraph 5.1.10.5.5
- Choice of power source – 110 VAC, 9V battery
- Provides both an audio (~90 dB @ 10 feet) and a visual alarm
- Mating inlet and outlet connections

### HOW TO ORDER

(Replace the PSI in P/N with the desired activation pressure)

Model Number	Description
9910-PSI-CGA	110 VAC brass unit with audio/visual alarm and silence button
9911-PSI-CGA	9 volt brass unit with audio/visual alarm and on/off switch (no silence button)
9910-PSI-P4FF	110 VAC brass unit with audio/visual alarm and silence button – 1/4" NPTF
9911-PSI-P4FF	9 volt brass unit with audio/visual alarm and on/off switch (no silence button)
9920-PSI-CGA	110 VAC SS unit with audio/visual alarm and silence button
9921-PSI-CGA	9 volt SS unit with audio/visual alarm and on/off switch (no silence button)
9920-PSI-P4FF	110 VAC SS unit with audio/visual alarm and silence button – 1/4" NPTF
9921-PSI-P4FF	9 volt SS unit with audio/visual alarm and on/off switch (no silence button)

## CUSTOM SYSTEMS

Most of the components in this catalog are used in combination with other components in their final application. Often it is convenient to combine these components on a panel, in a cabinet, or some other system configuration prior to the shipment of the components. This service offers convenience and often saves both time and money while ensuring that the user has all of the capability he requires when the product is received.

To take advantage of this service provide us with a flow sketch of the system and a brief written commentary of the system requirements; pressures, flow rates, gas, desired materials of construction, purification requirements, etc. or contact our technical service personnel to discuss your needs.

Some typical systems are shown on this page and the next.

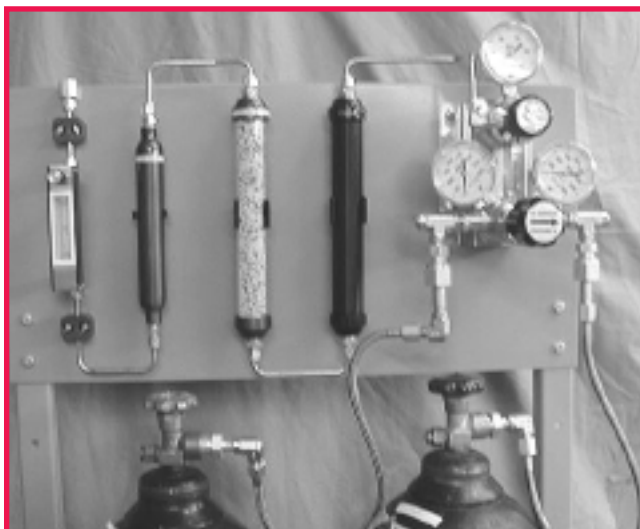

Typical gas purifier panel

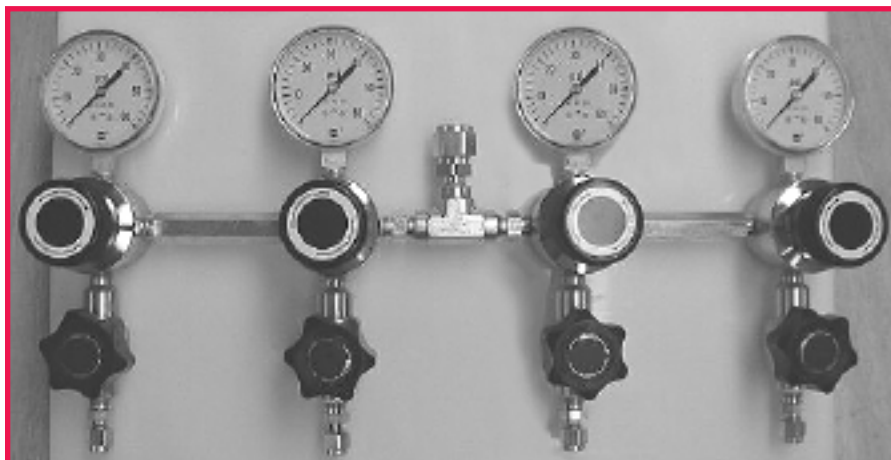

Laboratory line regulator 4-drop panel



line regulator manifold panel

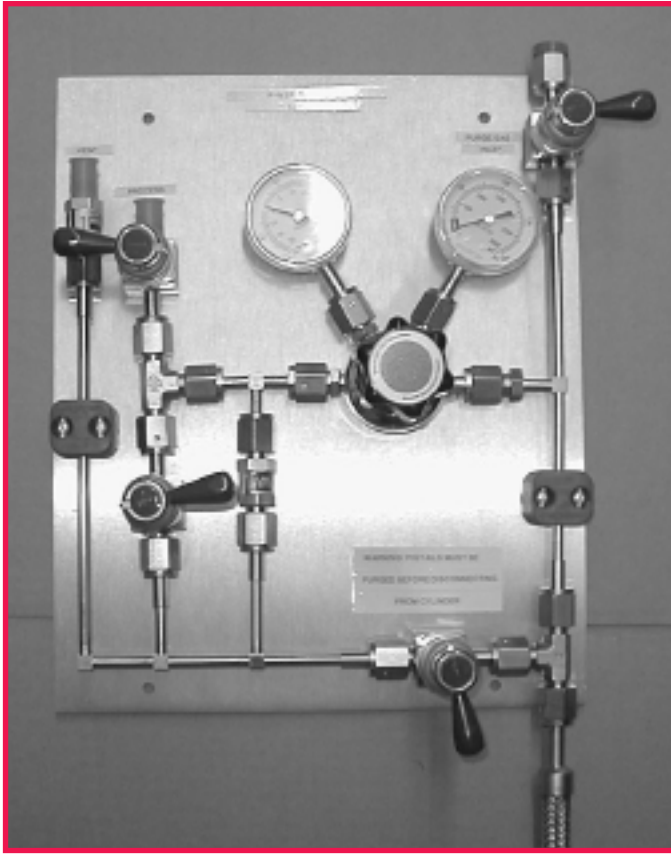

Typical semiconductor gas panel

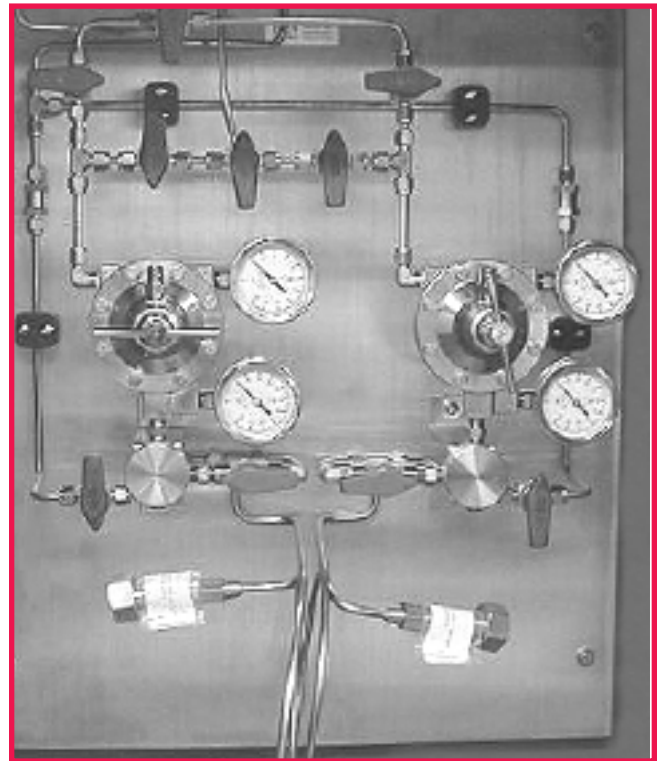

Gas cabinet control panel for chlorine

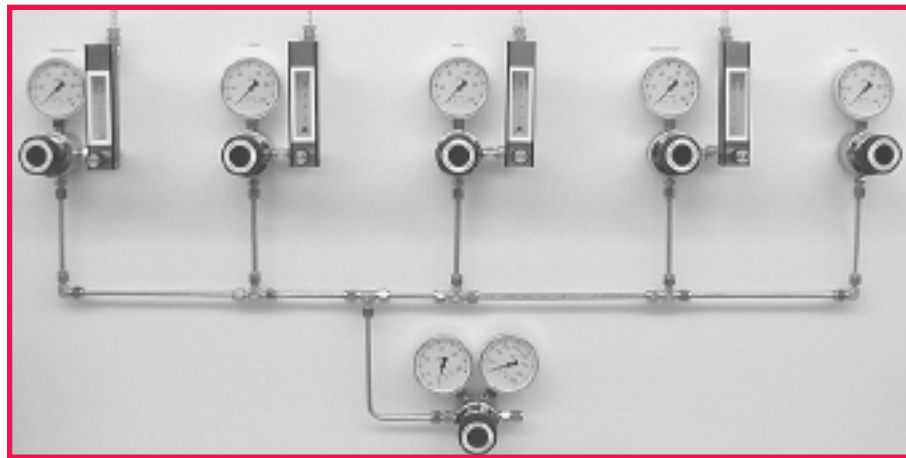

Two stage gas distribution panel

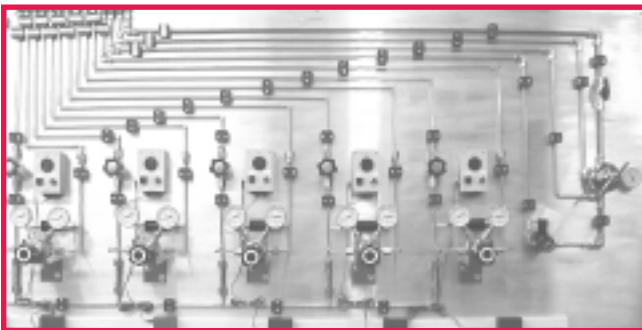

High purity distribution panel

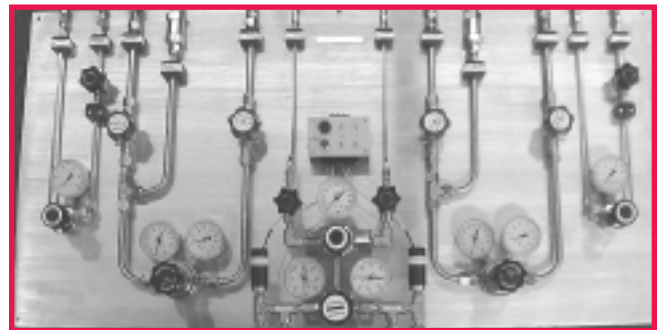

High purity changeover manifold with distribution

## PURGE ASSEMBLIES

### DESCRIPTION

The installation of a purge assembly on the inlet of your pressure regulator, pigtail inlet, or gas control system is highly recommended anytime a toxic, corrosive, flammable, or ultra high purity gas is to be used in the system. Purge assemblies perform the following multiple functions in your gas system during cylinder change-overs:

- Eliminate the release of toxic, corrosive, or flammable gases into the workplace.
- Maintain the integrity of an ultra high purity system.
- Protect equipment in corrosive gas service from exposure to moisture, thus preventing destructive corrosion.

## DEEP PURGE VALVE SYSTEM Series 4800

### DESCRIPTION

The Series 4800 deep purge valve system provides the ultimate in purging capability in a compact design with a very small internal volume. These units can be used in a wide variety of applications where contamination must be avoided during cylinder changeovers.

The deep purge valve system is an ideal accessory installed between the cylinder and the regulator of ultra high purity carrier lines for gas chromatography systems that cannot tolerate even a minimum amount of oxygen and moisture that can enter the system during cylinder changeovers.

The deep purge valve system can be used with gas mixtures containing reactive components to ensure that no moisture enters the sampling system to cause deterioration of the reactive components that can lead to concentration inaccuracies. Use of the 4820 also provides protection from the release of toxic gases into the atmosphere during cylinder changeovers.

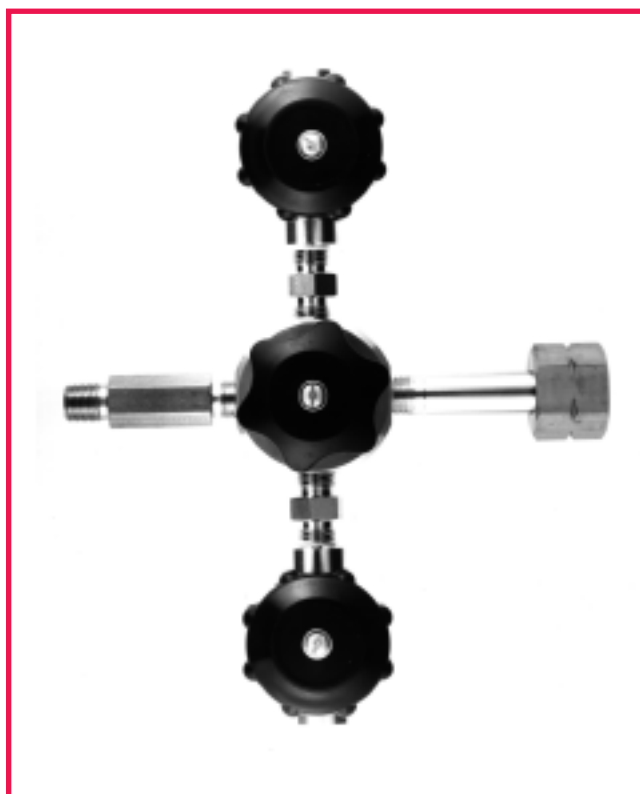

### HOW TO ORDER

Model	Material of Construction	Valve Type	Connections	
			Inlet	Outlet
4820-P4FF	stainless steel	multi-turn	1/4" NPT female	1/4" NPT female
4820-P4FM	stainless steel	multi-turn	1/4" NPT female	1/4" NPT male (3" nipple)
4820-CGA	stainless steel	multi-turn	specify CGA	1/4" NPT male (3" nipple)
4821-P4FF	stainless steel	90° lever	1/4" NPT female	1/4" NPT female
4821-P4FM	stainless steel	90° lever	1/4" NPT female	1/4" NPT male (3" nipple)
4821-CGA	stainless steel	90° lever	specify CGA	1/4" NPT male (3" nipple)
4822-CGA	stainless steel	multi-turn	specify CGA	mating CGA
4823-CGA	stainless steel	90° lever	specify CGA	mating CGA

## TEE PURGE ASSEMBLIES Series 4500

### DESCRIPTION

The Series 4500 tee purge assemblies are designed to be installed between the cylinder valve and the pressure regulator. They enable the user to purge the system through the regulator with an inert gas.

The Series 4500 units feature multi-turn diaphragm packless valves and a check valve installed on the purge gas inlet. They are rated for 3000 psig.

### HOW TO ORDER

Model	Material of Construction
4510-CGA*	brass
4520-CGA*	stainless steel
4550-CGA*	monel® and Al-Si-Bronze

\*Specify CGA connection required when ordering



Series 4500

## TEE PURGE ASSEMBLIES Series 4600

### DESCRIPTION

The Series 4600 tee purge assembly was designed for use with inert gases such as argon, helium, and nitrogen. When installed either on the inlet to a pressure regulator or on the cylinder end of a pigtail they are an ideal device for purging the cylinder inlet connection after cylinder changeover to eliminate the introduction of oxygen and water to the system. These tee purges conveniently use the gas in the cylinder for purging.

The Series 4600 can be constructed either with multi-turn or 90° lever actuated diaphragm packless valves. This entire assembly is designed to pass a helium leak rated of  $1 \times 10^{-9}$  sccm. They are rated for 3000 psig.

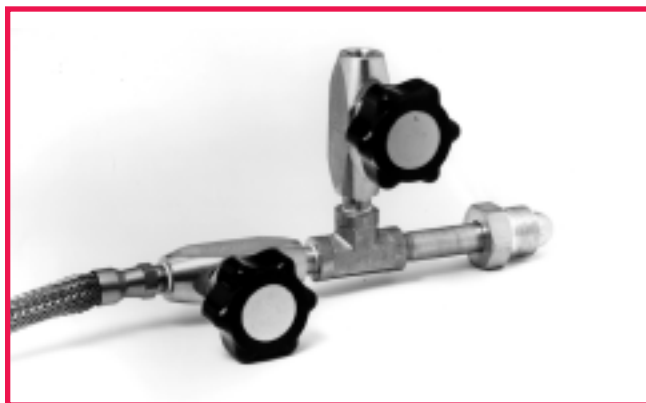

Series 4600

### HOW TO ORDER

Model*	Mat. of Constr.	Connections	
		Inlet	Outlet
4610-P4FF multi-turn	brass	1/4" NPT female	1/4" NPT female
4611-P4FF 90° lever	brass	1/4" NPT female	1/4" NPT female
4610-CGA multi-turn	brass	specify CGA	1/4" NPT female
4610-CGA 90° lever	brass	specify CGA	1/4" NPT female
4610M-CGA multi-turn	brass	specify CGA	1/4" NPT male
4611M-CGA 90° lever	brass	specify CGA	1/4" NPT male
4610F-CGA multi-turn	brass	specify CGA	1/4" NPT female
4611F-CGA 90° lever	brass	specify CGA	1/4" NPT female
4612-CGA multi-turn	brass	specify CGA	mating CGA
4613-CGA 90° lever	brass	specify CGA	mating CGA
4620-P4FF multi-turn	ss	1/4" NPT female	1/4" NPT female
4621-P4FF 90° lever	ss	1/4" NPT female	1/4" NPT female
4620-CGA multi-turn	brass	specify CGA	1/4" NPT female
4620-CGA 90° lever	brass	specify CGA	1/4" NPT female
4620M-CGA multi-turn	ss	specify CGA	1/4" NPT male
4621M-CGA 90° lever	ss	specify CGA	1/4" NPT male
4620F-CGA multi-turn	ss	specify CGA	1/4" NPT female
4621F-CGA 90° lever	ss	specify CGA	1/4" NPT female
4622-CGA multi-turn	ss	specify CGA	mating CGA
4623-CGA 90° lever	ss	specify CGA	mating CGA

\*Specify CGA connection required when ordering

## MINIATURE FORGED NEEDLE VALVES Series 8100

### DESCRIPTION

These valves are used in a wide variety of industrial and laboratory applications. They offer excellent flow control and both the brass and stainless steel models have Teflon® packing.

### SPECIFICATIONS

Max. operating pressure: 3000 psig

Operating temperature range: -65° to 165°F

Flow coefficient(C<sub>v</sub>): 0.35

### HOW TO ORDER

Brass	Model		Pattern	Connections
	316 SS	Monel		
8111	8121	--	Straight	1/8" NPT male
8112	8122	8152	Straight	1/4" NPT male
8112A	--	8122A	Angle	1/4" NPT female
8113	8123	--	Straight	1/4" compression

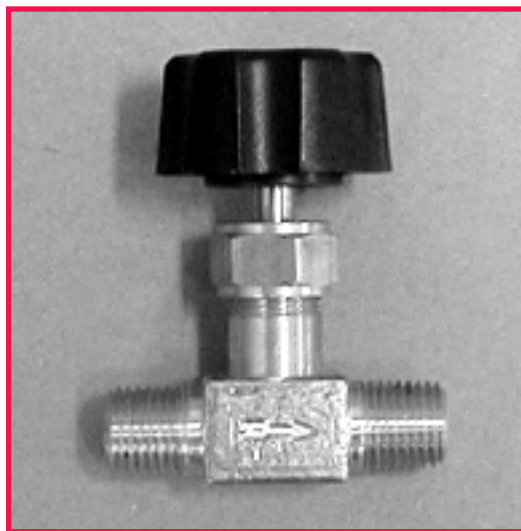

## CHECK VALVES Series 8400

### DESCRIPTION

Check valves prevent the return flow of gas, thus keeping foreign substances out of lines, regulators, and cylinders located upstream of the valve.

These valves are a spring loaded design with the spring on the high pressure side to protect it from foreign substances. The positive stop prevents over-stressing of the spring by sudden surges of gas pressure. An o-ring at the valve seat provides quick, efficient sealing.

The valves have a one piece body with 1/4" NPT female connections inlet and outlet. It is rated for 3000 psig with a cracking pressure of approximately 1 psig.

### HOW TO ORDER

Model	Materials of Construction
8410V	Brass body, Viton® o-ring, st. st. spring
8420E	316 st. st., EPR o-ring, st. st. spring
8420V	316 st. st., Viton® o-ring, st. st. spring
8450V	Monel®, Viton® o-ring, st. st. spring

Note: Check valves with other o-ring materials are available.



# HIGH PURITY DIAPHRAGM PACKLESS VALVES

## Series 8300

### DESCRIPTION

The multiple metal diaphragm design and Kel-F® seat are the key elements to the high purity success of these valves. They are available in a variety of styles and fitting configurations to meet virtually any application.

The 90° lever operated option provides the inherent benefits of a diaphragm packless valve with the quick open/close action and easily identifiable operational status of a lever actuated valve.

### FEATURES

- Metal diaphragm packless construction for diffusion resistant operation.
- Capable of passing a helium leak-rate test to 10<sup>-10</sup>cc/sec
- Available in multiple turn and 90° lever operated designs.

### APPLICATIONS

The Series 8300 valves are recommended whenever the diffusion of atmospheric gases and moisture into a gas system is undesirable. They are a must in all ultra high purity gas transfer systems, particularly those used for gas chromatography carrier gases, samples, and calibration standards.



### MATERIALS OF CONSTRUCTION

	Series 8310	Series 8320
Body	Brass	316 Stainless Steel
Seat	Kel-F®	Kel-F®
Diaphragm	Stainless Steel	Stainless Steel

### SPECIFICATIONS

Operating pressure: brass - 3000 psig  
 stainless steel - 3000 psig

Operating temperature range: 40° to 140°F

Flow coefficient(C<sub>v</sub>): 0.13

### HOW TO ORDER

Model*	Actuation	Connections	
		Inlet	Outlet
8310-P4FF	Multi-turn	1/4" NPT female	1/4" NPT female
8310L-P4MF	Multi-turn	1/4" NPT male long	1/4" NPT female
8310-P4MM	Multi-turn	1/4" NPT male	1/4" NPT male
8310-T4FF	Multi-turn	1/4" compression	1/4" compression
8320-P4FF	Multi-turn	1/4" NPT female	1/4" NPT female
8320L-P4MF	Multi-turn	1/4" NPT male long	1/4" NPT female
8320-P4MM	Multi-turn	1/4" NPT male	1/4" NPT male
8320-T4FF	Multi-turn	1/4" compression	1/4" compression
8321-P4FF	90° lever	1/4" NPT female	1/4" NPT female
8321L-P4MF	90° lever	1/4" NPT male long	1/4" NPT female
8321-P4MM	90° lever	1/4" NPT male	1/4" NPT male

\*Other end connection configurations available on request.

# RELIEF VALVES

## Series 8600

### DESCRIPTION

These easily field adjustable relief valves provide for the protection of equipment components installed in systems where they may be exposed to over pressurization due to the failure of another component or an operator error.

### FEATURES

- Working pressure to 3000 psig
- Wide range of pressure adjustment.
- 100% tested for crack and reseal performance
- Available in brass and stainless steel

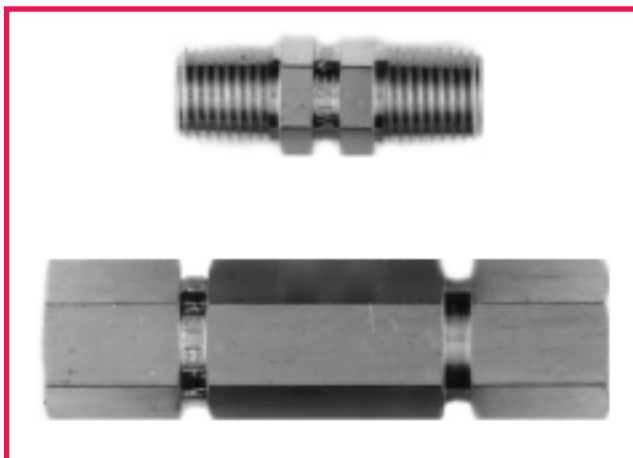

### SPECIFICATIONS

Maximum Working Pressure @ 70°F.	3000 psig
Flow Coefficient (C <sub>v</sub> ):	0.35
Temperature Rating:	
with Buna-N o-ring	-10 to 250°F.
with Viton® o-ring	-10 to 375°F.
O-ring Material: brass	Buna-N
stainless steel	Viton®

### HOW TO ORDER

Model	Material	Adjustable Range	Connections inlet x outlet
8614-20-P4MM	brass	3-20 psig	1/4" NPT male x 1/4" NPT male
8614-65-P4MM	brass	20-65 psig	1/4" NPT male x 1/4" NPT male
8614-175-P4MM	brass	65-175 psig	1/4" NPT male x 1/4" NPT male
8614-350-P4MM	brass	175-350 psig	1/4" NPT male x 1/4" NPT male
8614-600-P4MM	brass	350-600 psig	1/4" NPT male x 1/4" NPT male
8614-20-P4FF	brass	3-20 psig	1/4" NPT female x 1/4" NPT female
8614-65-P4FF	brass	20-65 psig	1/4" NPT female x 1/4" NPT female
8614-175-P4FF	brass	65-175 psig	1/4" NPT female x 1/4" NPT female
8614-350-P4FF	brass	175-350 psig	1/4" NPT female x 1/4" NPT female
8614-600-P4FF	brass	350-600 psig	1/4" NPT female x 1/4" NPT female
8624-20-P4MM	stainless	3-20 psig	1/4" NPT male x 1/4" NPT male
8624-65-P4MM	stainless	20-65 psig	1/4" NPT male x 1/4" NPT male
8624-175-P4MM	stainless	65-175 psig	1/4" NPT male x 1/4" NPT male
8624-350-P4MM	stainless	175-350 psig	1/4" NPT male x 1/4" NPT male
8624-600-P4MM	stainless	350-600 psig	1/4" NPT male x 1/4" NPT male
8624-20-P4FF	stainless	3-20 psig	1/4" NPT female x 1/4" NPT female
8624-65-P4FF	stainless	20-65 psig	1/4" NPT female x 1/4" NPT female
8624-175-P4FF	stainless	65-175 psig	1/4" NPT female x 1/4" NPT female
8624-350-P4FF	stainless	175-350 psig	1/4" NPT female x 1/4" NPT female
8624-600-P4FF	stainless	350-600 psig	1/4" NPT female x 1/4" NPT female

## MANUAL CONTROL VALVES

### Series 8500

#### DESCRIPTION

Manual controls are designed for direct connection to a compressed gas cylinder valve outlet. They provide a simple means of transferring the contents of a cylinder to another system or vessel. They **DO NOT** control pressure and should never be used without an operator in attendance at all times.

Four models are presented here with the following basic design features:

- Maximum inlet pressure - 3000psig.
- Teflon® packing for smooth leak-free operation.
- Finger-tip control of flow from only a few cc per minute to very rapid withdrawal.



#### Series 8523 - 303 Stainless Steel with 0-3000 psig Cylinder Pressure Gauge

Model	Outlet Connection
8523H*	1/4" hose barb
8523T*	1/4" compression fitting
8523PF*	1/4" NPT female

\*Specify CGA connection number when ordering.

#### Series 8550 - Monel®

Model	Outlet Connection
8550H*	1/4" hose barb
8550T*	1/4" compression fitting
8550PF*	1/4" NPT female

\*Specify CGA connection number when ordering.

#### HOW TO ORDER

##### Series 8520 - 303 Stainless Steel

Model	Outlet Connection
8520H*	1/4" hose barb
8520T*	1/4" compression fitting
8520PF*	1/4" NPT female

\*Specify CGA connection number when ordering.

## EASY-MOUNT REGULATOR BRACKET

### Series EZ3000

This bracket allows either single stage or two stage regulators to be mounted or removed without removing the adjusting knob or resetting the delivery pressure provided the regulator is supplied by the factory with the panel mount nut installed. The bracket will accommodate any bar stock panel mountable regulator shown in this catalog.

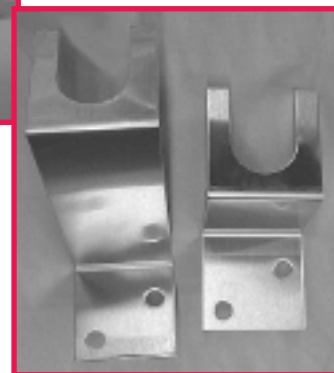

#### HOW TO ORDER

Model	Description
EZ3100	For single stage regulators
EZ3200	For two stage regulators

## **GAS DETECTION SYSTEMS**

### **Fixed Installation Type – Beacon 100, Beacon 200, and Beacon 800**

#### **FEATURES**

- Low cost versatile solution!!
- Compact, weatherproof, NEMA 4X enclosure
- 115 VAC or 12 VDC operation
- Long life sensors (2+ years typical)
- Accepts LEL/O<sub>2</sub>/H<sub>2</sub>S/CO direct wire sensors(Beacon 100 & 200)
- Accepts any 4-20 mA transmitter
- Audible alarm with reset button
- Three programmable alarm levels
- Built-in trouble alarm with relay
- Relay rating 10 or 12 amps, form C
- Provides 4-20 mA output

#### **INDUSTRY APPLICATIONS**

- Laboratories
- Semiconductor manufacturing facilities
- Petrochemical plants & refineries
- Water & wastewater treatment plants
- Pulp & paper mills
- Gas, telephone, & electric utilities
- Parking garages
- Manufacturing facilities

#### **DESCRIPTION**

Gas detection should not be complicated. The Beacon™ Series is gas detection simplified. The Beacon™ Series are powerful, low cost fixed system controllers for one, two, or up to eight points of gas detection. They are microprocessor controlled, versatile, simple to install and operate, and priced to be the industry's best value single and multiple gas detection controllers.

The wide variety of sensor heads available for the Beacon Series can provide protection for many of the gases commonly used in industry or laboratories today. A comprehensive list of available detectors is provided below.

Sensors can be mounted directly at the Beacon™ housing, or can be wired remote from the controller. The digital displays have backlighting and simultaneous readout of the gas type(s) and concentration(s). The bottom mounted wiring hubs make wiring easy. An external reset switch allows alarms to be silenced from outside the controller housing.

With 10 or 12 amp rated relays, the Beacon Series can be wired directly to a variety of devices like horns, buzzers, or lights eliminating the need for costly external relays from the controller to devices.



The Beacon™ Series is housed in a NEMA 4X rated case for a weather tight seal. This case design complies with the new lock out / tag out standard and can be fully secured. An external reset switch allows the alarm to be silenced from outside of the controller housing. The Beacon™ units ship complete with a wall mounting kit for easy installation.

#### **ABOUT SENSORS**

The sensor is the actual device that is sensing the gas. Three sensor types are available for use with the Beacon Series Controller: direct wire, gas diffusion, and sample draw. Sensors typically last 2 to 4 years, but can last for a longer or shorter time depending on the nature of the application.

#### **DIRECT WIRE DETECTORS**

Direct wire detectors are hard wired diffusion sensors to the controller and do not require a transmitter. They are, therefore, more economical than detectors requiring a transmitter. Direct wire detectors can only be used with the Beacon 100 & 200 controllers. While the choice of gases is limited for hard wire detectors they can be an economical choice when available. In general, the use of a transmitter is preferred for distances over 300' to 500' to simplify calibration.

## DIFFUSION DETECTORS

Diffusion detectors rely on the natural flow of air to bring the sample to the detection head. These are an excellent choice for gas cabinets or other forced flow environments where the detector is situated in a constant air flow from the potential gas release to the detector. All diffusion type detectors used with the Beacon Series have transmitters.

## SAMPLE DRAW DETECTORS

Sample draw detectors have an integral pump, which draws the surrounding air to the detector. They are a preferred choice when used in larger areas where there is no specific point at which one can expect a gas leak. All sample draw detectors used with the Beacon Series have transmitters.

## TRANSMITTERS,

Most sensors require a transmitter to amplify the sensor signal, and to convert the gas sensor signals into a standardized output, such as 4-20 mA, for transmitting the signal to a controller. The transmitter is usually in close proximity to the sensor, and zero and span adjustments must be done at the transmitter. Note that some sensors and controllers do not require the use of a transmitter for LEL or Oxygen detection (Beacon 100 & Beacon 200), and also one is not needed for short distance wiring of H<sub>2</sub>S or CO sensors for the Beacon 100 & 200. All transmitters used with the Beacon Series are operated from 24 VDC, and utilize either 2 or 3 wires. In general, even if a sensor can be used without a transmitter, the use of a transmitter is often preferred for distances over 300' to 500' to simplify calibration.

## HOW TO ORDER

When ordering a Beacon system please specify the following components:

1. Controller part number
2. Detector assemblies required (select from list on page 89)

Model	Description
72-2101 RK	Beacon 100 single point controller
72-2102 RK	Beacon 200 two point controller
72-2108 RK	Beacon 800 eight point controller



---

## SPECIFICATIONS

### PHYSICAL

Enclosure:	Wall mounting gray polycarbonate with hinged cover		
Dimensions:	Beacon 100	Beacon 200	Beacon 800
	Height: 8.5	Height: 8.5"	Height: 12.5"
	Width 7.0"	Width: 7.0"	Width: 11.0"
	Depth 4.3"	Depth: 4.3"	Depth: 6.4"
Conduit Connection			
1/2" NPT conduit hubs:	2	3	4
Wiring Termination:	Screw type terminal block 14 gauge max.		
Environmental			
Operating Temp	-4°F to 122°F (-20°C to 50°C)		
Storage Temp	-4°F to 158°F (-20°C to 70°C)		
R relative Humidity:	0 - 100% RH		
Enclosure Rating:	NEMA-4X enclosure, waterproof, chemical, and weather resistant.		

### INPUTS

Direct Wired Sensors (Beacon 100 & 200 only)

LEL / PPM Hydrocarbon

Oxygen

Carbon Monoxide

Hydrogen Sulfide

Remote amp not required for less than 500 feet.

4-20 mA Sensors: Accepts any 4-20 mA transmitter (24VDC, 2 or 3 wire). A wide variety of sensors are available with 4-20 mA signals. (See list of detectable gases. Wiring distances up to 5000 feet.

### OUTPUTS

#### Relays:

Beacon 100: 4 relays - 12 amp rating (at 115 VAC), SPDT isolated contacts. 3 relays for gas alarm levels 1 relay for malfunction

Beacon 200: 2 relays per channel – 10 amp rating (@115 VAC), SPDT isolated contacts. 1 set of common relays: 2 for gas alarm levels, 1 for malfunction

Beacon 800: 2 relays per channel - 10 amp rating (@115 VAC), SPDT isolated contacts. 1 set of common relays: 2 for gas alarm levels, 1 for malfunction

Relays fully programmable for: increasing or decreasing alarm, latching or self reset, normally energized or normally de-energized, time delay for alarm on and alarm off.

4-20 mA Signal output, 4-20 mA (into 500 ohms impedance maximum).

24 VDC 24 VDC output provided to operate sample drawing adapters or other accessories.

**Display:** Alphanumeric display with back-lighting.

Beacon 100: 1 display, 16 characters per line; 2 lines.

Beacon 200: 1 display, 20 characters per line; 4 lines

Beacon 800: 2 displays, 16 characters per line; 4 lines each. All 8 channels continuously displayed.

**Audible:** Built-in audible alarm, 94 dB, mounted on enclosure. Coded Output: pulsing = gas alarm steady = fail

**Visual:** Beacon 100: 5 visual alarm LED's on the front cover for status indication, pilot, and malfunction.

Beacon 200: 4 visual alarm LED's on the front cover for status indication, pilot, and malfunction.

Beacon 800: 4 visual LED alarms on front cover for alarm indications, pilot, and malfunction.

### POWER

115 VAC or 12 VDC standard

Optional: 230 VAC

Battery backup option available

### WARRANTY

Two years materials and workmanship.

Measurable Gases	Standard Range	Diffusion Detector Assembly	Sample Draw Detector Assembly	Sensors For		
				100	200	800
Ammonia NH3	0 - 75 ppm	GD-K8A-NH3	GD-K7D2 NH3	X	X	X
Arsine AsH3	0 - 0.2 ppm	-	GD-K7D2ASH3	X	X	X
Boron Trichloride BCl3	0 - 15 ppm	GD-K8A-BCL3	GD-K7D2 BCL3	X	X	X
Boron Trifluoride BF3	0 - 9 ppm	-	GD-K7D2 BF3	X	X	X
Carbon Tetrachloride CCl4	0 - 30 ppm	-	GD-K8DT-CCL4	X	X	X
Carbon Monoxide (XP) CO	0 - 300 ppm	65-2432RK		X	X	X
Chlorine Cl2	0 - 3 ppm	GD-K8A-CL2	GD-K7D2 Cl2	X	X	X
Chlorine Trifluoride ClF3	0 - 1 ppm	-	GD-K7D2 ClF3	X	X	X
Combustibles (XP) LEL	0 - 100 %	61-1000RK		X	X	
Combustibles (4-20mA) (XP) LEL	0 - 100 %	65-2400RK	-	X	X	X
Diborane B2H6	0 - 0.3 ppm	GD-K8A-B2H6	GD-K7D2 B2H6	X	X	X
Dichlorosilane DCS	0 - 15 ppm	GD-K8A-DCS	GD-K7D2 DCS	X	X	X
Disilane Si2H6	0 - 15 ppm	GD-K8A-SI2H6	GD-K7D2 Si2H6	X	X	X
Fluorine F2	0 - 3 ppm	-	GD-K7D2 F2	X	X	X
Germane GeH4	0 - 2 ppm	-	GD-K35PN-GEH4	X	X	X
Hydrazine N2H4	0 - 10 ppm	-	GD-K34PN-N2H4	X	X	X
Hydrogen H2	0 - 2000 ppm	GD-A8V-H2	GD-D8V-H2	X	X	X
Hydrogen (Direct) H2	0 - 2000 ppm	61-1050RK		X	X	
Hydrogen (Specific) H2LEL	0 - 100%	61-1001RK		X	X	
Hydrogen (4-20mA) H2	0 - 2000 ppm	65-2440RK		X	X	X
Hydrogen Bromide HBr	0 - 9 ppm	-	GD-K7D2 HBr	X	X	X
Hydrogen Chloride HCl	0 - 15 ppm	-	GD-K7D2 HCl	X	X	X
Hydrogen Chloride HCl	0 - 15 ppm	GD-K8A-HCL		X	X	X
Hydrogen Cyanide HCN	0 - 30 ppm	-	GD-K35PN HCN	X	X	X
Hydrogen Cyanide HCN	0 - 40 ppm	GD-K8A-HCN	GD-K7D2 HCN	X	X	X
Hydrogen Fluoride HF	0 - 9 ppm	-	GD-K7D2 HF	X	X	X
Hydrogen Selenide H2Se	0 - 0.2 ppm	-	GD-K35 H2Se	X	X	X
Hydrogen Sulfide H2S	0 - 1 ppm	-	GD-K7D2 H2S	X	X	X
Hydrogen Sulfide H2S	0 - 100 ppm	65-2422RK	-	X	X	X
Nitric Oxide NO	0 - 100 ppm	-	GD-K7D2 NO	X	X	X
Nitrogen Dioxide NO2	0 - 15 ppm	GD-K8A	GD-K7D2 NO2	X	X	X
Nitrogen Trifluoride NF3	0 - 30 ppm	-	GD-K8D NF3	X	X	X
Nitrogen Tetraoxide N2O4	0 - 15 ppm	-	GD-K7D2 N2O4	X	X	X
Oxygen (4-20mA) O2	0 - 25 %	65-2504RK	-	X	X	X
Oxygen (Direct) O2	0 - 25 %	65-2502RK	-	X	X	
Ozone O3	0 - 1 ppm	GD-K8A-O3	GD-K7D2 O3	X	X	X
Phosphine PH3	0 - 1 ppm	GD-K8A-PH3	GD-K7D2 PH3	X	X	X
Phosphorus Pentafluoride PF5	0 - 9 ppm	-	GD-K7D2 PF5	X	X	X
Phosphorus Trichloride PCI3	0 - 15 ppm	GD-K8A-PCL3	GD-K7D2 PCI3	X	X	X
Phosphorus Trifluoride PF3	0 - 9 ppm	-	GD-K7D2 PF3	X	X	X
Silane SiH4	0 - 15 ppm	GD-K8A-SIH4	GD-K7D2 SiH4	X	X	X
Silicon Tetrachloride SiCl4	0 - 15 ppm	GD-K8A-SICL4	GD-K7D2 SiCl4	X	X	X
Silicon Tetrafluoride SiF4	0 - 9 ppm	-	GD-K7D2 SiF4	X	X	X
Sulfur Dioxide SO2	0 - 30 ppm	GD-K8A-SO2	GD-K7D2 SO2	X	X	X
Sulfur Tetrafluoride SF4	0 - 9 ppm	-	GD-K7D2 SF4	X	X	X
Tetraethyl Orthosilicate TEOS	0 - 15 ppm	-	GD-S8DG-TEOS	X	X	X
Trichlorosilane TCS	0 - 15 ppm	GD-S8DG-TCS	GD-K7D2 TCS	X	X	X
Tungsten Hexafluoride WF6	0 - 9 ppm	-	GD-K7D2 WF6	X	X	X
1,1,1-Trichloroethane C2H3Cl3	0 - 2000 ppm	GD-A8V	-	X	X	X

## EAGLE PORTABLE GAS DETECTOR

### DESCRIPTION

The EAGLE is a powerful instrument that does more than offer standard confined space protection. The EAGLE also provides detection combinations never before offered in a portable gas monitor featuring the industry's widest selection of high quality, long life and field proven sensors.

The EAGLE's ergonomic design offers easy access to controls such as auto-calibration, alarm silence, demand zero, peak hold and a wide variety of other features. Each channel has 2 alarm levels plus TWA and STEL alarms for toxic channels. Alarm levels are adjustable and can be latching or self resetting. Standard features on the EAGLE, such as PPM/LEL hydrocarbon detection (5 ppm resolution) and a methane elimination switch for environmental applications are not available on most other competitive units. For quick response and recovery, the EAGLE has a strong internal pump that can draw samples from over 125 feet. The EAGLE will continuously operate for over 30 hours on alkaline batteries or 18 hours on rechargeable Ni-Cads. Many accessories such as long hoses, special probes, data-logging, continuous operation adapters, remote alarms and strobes, dilution fittings, internal hydrophobic filter, etc. are available to help satisfy almost any application. Rugged, weatherproof, easy to operate and maintain, the EAGLE is the industry's answer to portable gas detection.

### FEATURES

- Simultaneous detection of up to 6 different gases
- Wide variety of field proven gas sensors available
- PPM / LEL hydrocarbon detection
- Powerful long-life pump with 125' range
- Low flow pump shut off and alarm
- Methane elimination switch for environmental use
- Security "Adjustment Lockout Switch"
- Up to 30 hours of continuous operation
- Alkaline or Ni-Cad capability
- Ergonomic RFI/EMI/Chemical resistant case
- Data-logging option
- Auto-calibration
- Intrinsically safe design (most versions), CSA/NRTL & UL Classified



### HOW TO ORDER\*

Measurable Gas**	Range	Model Number
Ammonia	0-75 ppm	72-5111RK
Arsine	0-0.20 ppm	72-5107RKS
Arsine	0-1.0 ppm	72-5107RK
Carbon Dioxide	0-5000 ppm	72-5115RK-5K
	0-10000 ppm	72-5115RK-10K
	0-5%	72-5115RK-05
	0-20%	72-5115RK-20
	0-50%	72-5115RK-50
Carbon Monoxide	0-500 ppm	72-5104RK
Fluorine	0-5 ppm	72-5119RK
Hydrocarbon	0-100% LEL &	72-5101RK
	0-50,000 ppm	
Hydrogen Chloride	0-5 ppm	72-5110RK
Hydrogen Sulfide	0-100 ppm	72-5103RK
Nitrogen Dioxide	0-15 ppm	72-5114RK
Oxygen	0-40%	72-5102RK
Phosphine	0-1.0 ppm	72-5108RK
Silane	0-15 ppm	72-5117RK
Sulfur Dioxide	0-30 ppm	72-5105RK
Confined Space Instrument	(4 detectors in one housing)	72-5401RK
	Hydrocarbons	0 - 100% LEL 0 - 50,000 ppm
	Oxygen (O <sub>2</sub> )	0 - 40% Vol.
	Carbon Monoxide (CO)	0 - 500 ppm
	Hydrogen Sulfide (H <sub>2</sub> S)	0 - 100 ppm

\*Included Accessories – Most Eagle units come with a 5' polyurethane hose, shoulder strap, four alkaline batteries, and a 10" hydrophobic probe as standard accessories. Units for toxic gases are supplied with a 3' Teflon hose without the hydrophobic filter.

\*\*Gases & Detectable Ranges - The EAGLE can be provided with many gas sensors not specifically listed above. Units can contain up to 6 gas sensors (4 Toxics maximum). Please specify the gases desired when requesting a quotation.

---

## **EAGLE PORTABLE GAS DETECTOR – CONTINUED**

### **SPECIFICATIONS:**

Enclosure:	Weatherproof, chemical resistant, RF/EMI coated high impact poly-carbonate-polyester blend. Can be set in rain or into 2.5" of water without damage. Ergonomically balanced with rugged top mounted handle.
Dimensions:	10.5" long x 5.9" x 7" tall.
Weight:	5 lbs.
Detection Principle:	Catalytic combustion, electrochemical cell, and infrared.
Sensor Life:	2 years under normal conditions.
Sampling Method:	Powerful, long-life pump (over 6,000 hours) can draw samples over 125 feet. Flow rate approximately 2.0 SCFH.
Display :	4 x 20 LCD readout with backlighting. Viewed through window in case top. Displays readings & status of all channels simultaneously.
Alarms:	2 alarms per channel plus TWA and STEL alarms. Fully adjustable for levels, latching or self-reset and silenceable.
Alarm Method:	Buzzer 85dB at 30 cm, dual high intensity LED's, and blinking display.
Controls:	6 external push buttons for operation, demand zero, and auto-calibration. Buttons also access LEL/ppm, alarm silence, peak hold, TWA /STEL values, battery status and many other features.
Continuous Operating Hours:	30 hours minimum using alkaline batteries, or 18 hours using Ni-Cads.
Power Source:	Size D batteries, 4 alkaline or Ni-Cad. Charger has alkaline recognition to prevent battery damage if alkalines are charged.
Operating Temp. & Humidity	-10°C to 40°C (14°F to 104°F), 0 to 95% RH, non-condensing
Indication Accuracy:	Maximum variance +/- 5% of full scale.
Response Time:	30 seconds to 90% (for most gases).
Safety Design:	Intrinsically Safe, Class I, Division 1, Groups A, B, C and D. CSA / NRTL & UL Classified (most versions).
Standard Accessories:	Shoulder strap, alkaline batteries, hydrophobic probe, and 5 foot hose (for special toxic gas versions, shorter Teflon hose used without probe).
Optional Accessories	<ul style="list-style-type: none"><li>• Data-logging of up to 4 gases (No data-logging possible on 5 or 6 gas versions or versions with more than 2 toxic (Sensors)</li><li>• Remote alarm</li><li>• Dilution fitting (50/50)</li><li>• Ni-Cad batteries</li><li>• Battery charger, 115 VAC, 220 VAC, or 12 VDC</li><li>• Continuous Operation Adapter, 115 VAC or 12 VDC</li><li>• Extra loud buzzer</li><li>• Extension Probes</li><li>• Internal Hydrophobic Filter (strongly recommended)</li></ul>
Warranty	One year material and workmanship

---

## **GASWATCH 2 MINIATURE PORTABLE GAS DETECTORS**

### **DESCRIPTION**

The GasWatch 2 is the first single-gas monitor that can be comfortably worn on the wrist like a watch. The GasWatch 2 is a convenient, inexpensive, hands-free method of gas monitoring for personal protection of oxygen deficiency, carbon monoxide or hydrogen sulfide. The built in vibrator, audible, and visual alarms immediately alert the user of a dangerous gas condition.

The GasWatch 2 is controlled by a microprocessor for reliability and advanced capabilities. Some of these advanced capabilities include distinctive audible and visual alarms for dangerous gas conditions and malfunctions, a large digital readout with a manual backlight that also automatically lights in an alarm condition, as well as the display of PEAK, TWA, and STEL readings. The replacement sensors are inexpensive, easily field replaceable and have a life expectancy of about 2 years. Equipped with a watch band, optional belt clip or hard hat clip, the GasWatch 2 can be worn either on the wrist, belt, or hard hat.

The GasWatch 2 will operate for over 3000 hours on one battery (about 1 year normal use). And yes, the GasWatch 2 even tells the time!



### **FEATURES**

- Hands free gas monitoring
- 3 Gases to choose from CO, H<sub>2</sub>S, or O<sub>2</sub>
- Compact "watch type" design
- Vibration, visual and audible alarms standard
- Over 3,000 hours of operation from 1 battery
- Fast, accurate response with digital LCD display
- Fits on your arm, wrist, or belt
- One or two gas monitoring
- Manual backlight (Automatic light during alarm)
- Sensor fail alarm
- PEAK hold function (Max. value during operation)
- TWA and STEL function
- Includes time / clock LCD display

### **APPLICATIONS**

- Worker Safety
- Chemical Plants
- Hazardous Waste Sites
- Mines
- Tunnels
- Sewage Treatment Plants

## ***GASWATCH 2 MINIATURE PORTABLE GAS DETECTORS Continued***

<b>Gas Detected</b>	<b>Oxygen (O2 )</b>	<b>Carbon Monoxide (CO)</b>	<b>Hydrogen Sulfide (H2S)</b>
Model Name(Part #)	GW-2X 72-0007RK	GW-2H 73-0040RK	GW-2C 73-0041RK
Measuring Gas	O2	CO	H2S
Detection Principle	Galvanic cell	Electrochemical	
Sensor Type	OS-BM2	ES-1827	ES-1821
Measuring Range (Increments)	0 - 40.0% vol (0.1% vol.)	0 - 150.0 ppm (0.5 ppm)	0 - 500 ppm (1 ppm)
Alarm Points (Factory Set)	Decreasing - 19.5% vol Increasing - 23.5% vol Over - 40.0%	Low - 10 ppm High - 20 ppm TWA - 10.0 ppm STEL - 15.0 ppm Over - 100 ppm	Low - 25 ppm High - 50 ppm TWA - 25 ppm STEL - 200 ppm Over - 500 ppm
Alarm Types	Gas alarm: 2 step alarm, STEL, TWA, Over alarm Trouble alarm: sensor connection, low battery, circuit error Calibration range over alarm		
Alarm Indication	Gas alarm: flashing light, intermittent buzzer and pulsing vibration Trouble alarm: flashing light, intermittent buzzer and trouble type displayed		
Sampling Method.	Diffusion type		
Power Source	One coin type lithium battery (CR 2450)		
Continuous Operation	Approximately 3,000 hours with no alarms or backlighting (about 1 year of normal use)		
Safety Rating	Intrinsically safe		
Display Method	Digital LCD with auto back light		
Dimensions & Weight	2.5"w x 1.7"h x 0.9"d 2 ounces		
Operating Temp & Humidity	-10 ~ 40°C, Max 85% RH (non-condensing)		
Dimensions & Weight	2.81"w x 3.31"h x 1.16"d, 4.76 oz		
Features	LCD manual back light (automatic lighting during alarm) STEL, TWA function Peak hold Time indication		
Standard Accessory	Wrist strap		
Optional Accessory	Belt clip, hard hat clip		
Warranty	2 year material & workmanship		

\* Specifications subject to change without notice



# ECONOMICAL FLAMMABLE GAS & VAPOR DETECTOR

## Model PS-2

### DESCRIPTION

The PS-2 Series is a multipurpose gas monitor using a MOS (metal oxide sensor) for long lasting and low maintenance detection at the LEL and ppm levels of many flammable gases and vapors. It is an effective solution for solvent monitoring around degreasers or other processes, hydrogen monitoring in battery rooms, natural gas detection in basements, and many other applications.

The PS-2 has two alarm levels that are activated with increasing gas or vapor levels. Each alarm activates a 12 amp relay with terminals for connecting external alarms or to activate an exhaust fan or other device.

This stand alone unit is housed in a durable plastic enclosure with flanges provided for wall mounting. There are easy access wiring hubs on the bottom of the unit. The front panel contains three lights; Pilot, Alarm 1, and Alarm 2. There is an internal 85 dB audible alarm that is activated with a gas alarm condition. The PS-2 is supplied with a gas sensor located at the end of a 30' cable (other cable lengths are available) and can be powered by 115 VAC or 24 VDC. The AC version is supplied with a 6' power cord.

**Note: The PS-2 is not explosion proof. The control box must be located outside the hazardous area.**

### DETECTABLE GASES

The PS-2 and its MOS sensor effectively respond to a wide variety of hydrocarbons, flammable gases, and vapors. Alarms can be set for OSHA established TLV levels or LEL levels for flammable vapor warnings.

Since the PS-2 sensor is a general hydrocarbon sensor, it is not specific for any particular gas. This instrument will perform best if used in an area where there is the possibility that only a single gas or vapor contaminant will be present. If used in areas with multiple contaminants false alarms may occur.

### SPECIFICATIONS

Dimensions: 6.48" W x 6.85" H x 3.30" D  
Power: 115 VAC or 24 VDC  
Operating Temp: 35° to 120°F  
Rel. Humidity: 10 to 95% non-condensing  
Outputs: Two relays – 12 amps each  
Audible – 85 dB  
Visual – Alarm 1 Orange LED  
Alarm 2 Red LED



### PARTIAL LIST OF DETECTABLE GASES

Acetylene	Iso-butane
Acrylonitrile	Isopropyl alcohol
Buntane	Methane
Butadiene	Methylene Chloride
Butylene	Perchloroethylene
Cyclohexane	Propane
Ethane	Propylene
Ethyl Alcohol	Propylene Oxide
Ethylene	Toluene
Ethyl ether	Trichloroethane
Gasoline	Xylene
Hexane	
Hydrogen	

### HOW TO ORDER

P/N	Description
73-1020RK-01*	PS-2 for LEL detection, VDC powered
73-1020RK-02*	PS-2 for PPM detection, 24 VDC powered
73-1021RK-01*	PS-2 for LEL detection, 115 VAC powered
73-1021RK-02*	PS-2 for PPM detection, 115VAC powered

\* Specify gas or vapor to be detected when ordering.

## **SF6 LEAK DETECTOR**

### **Model 3-033-R002**

#### **DESCRIPTION**

The remarkable sensitivity of this hand held unit allows the user to detect sulfur hexafluoride to levels equivalent to 0.1 oz/year (3 grams/year). An advanced microprocessor is the heart of this unit. Its digital signal processing provides excellent management of the circuitry and sensing tip signal. The microprocessor monitors the sensing tip and battery voltage levels 4000 times per second, compensating for even the most minor fluctuations in signal. This translates into a stable and dependable tool in almost any environment.

Convenience features have been incorporated into the 3-033-R002 to enhance its operation. Seven levels of sensitivity provide and increase of 64 times from level 1 to level 7. Unique tri-color LEDs show a progressive and wide range of leak size indication, communicate the sensitivity level, and provide a true voltage indication of battery power level. A tactile keypad controls all functions. The housing design provides the user with a secure grip and control and places the visual indicators in direct sight during use.

#### **FEATURES**

- Microprocessor control with advanced signal processing.
- Seven sensitivity levels.
- Tactile keypad controls.
- Real-time SF6 sensitivity adjustment.
- Battery test function with battery voltage indication.
- True mechanical pumping ensures positive air flow through the sensing tip.
- Cordless and portable.
- 14" flexible stainless steel probe.
- Built-in mute feature.

#### **SPECIFICATIONS**

- Power supply: 3V DC - two "C" cell alkaline batteries.
- Max. Sensitivity: 0.1 oz/year (3 grams/year) SF6
- Operating temperature: 30° to 125°∞ F.
- Life: Approximately 30 hours normal use
- Response time: Instantaneous
- Reset time: one second
- Warm-up time: Approximately 2 seconds
- Unit weight: 1.2 pounds
- Dimensions: 9" x 2.5" x 2.5"



## CYLINDER HOLDING DEVICES

OSHA regulations require compressed gas cylinders to be secured from toppling when in storage or in use. The devices shown here will help you comply with these regulations.

### WALL MOUNT CYLINDER HOLDER - MODEL 400

This cast aluminum cylinder holder provides an easy way to secure cylinders to a wall, in a gas storage cabinet, or other stable surface. The holder is attached with bolts or lag screws using the pre-formed holes 7 inches apart. The holder can be used with cylinders from 4 to 14 inches in diameter. Cylinders are held firmly in place with a nylon strap fitted with a sturdy buckle, with an optional steel chain and hook, or both strap and chain

#### HOW TO ORDER

Model	Description
400	Wall mount cylinder holder with strap
400C	Wall mount cylinder holder with chain and hook
400CS	Wall mount cylinder holder with strap, chain and hook
400 RS	Replacement strap.



### BENCH TYPE CYLINDER HOLDER - MODEL 420

This holder is designed to prevent toppling of cylinders when they are next to a lab or work bench and cannot be secured to a wall. The special screw clamp holds securely to a table top without marring the surface. The holder can be used with cylinders from 4 to 14 inches in diameter. Cylinders are held firmly in place with a nylon strap fitted with a sturdy buckle, with an optional steel chain and hook, or with both strap and chain.

#### HOW TO ORDER

Model	Description
420	Bench mount cylinder holder with strap
420C	Bench mount cylinder holder with chain and hook
420CS	Bench mount cylinder holder with strap, chain and hook
400 RS	Replacement strap.

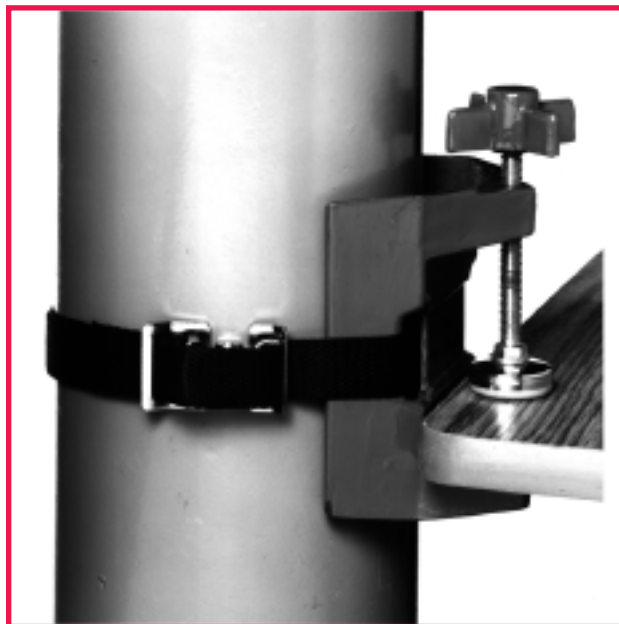

## **SMALL CYLINDER STAND Model 450**

### **DESCRIPTION**

This stand provides increased stability to cylinders with diameters of 4" to 7-3/8". It is constructed of nickel plated steel. Four thumb screws hold the stand securely to the cylinder. Stand height is 10".



## **LARGE CYLINDER STAND Model 460**

### **DESCRIPTION**

This stand provides increased stability to cylinders with a diameter of 9"-9.5" in situations where it is not possible to secure the cylinder to a wall or a bench with the model 400 or 420 cylinder holders. The cylinder can be rolled on and off with ease and is firmly held in place or quickly released by the cylinder holding band. With this unique design the cylinder rests on a steel plate and uses the cylinder's own weight to help keep the cylinder and stand stable and eliminate unsafe cylinder "ride up" that is common in some competitive models. Constructed of steel painted green.

Dimensions: 18" x 18" x 12.5" high

Weight: 13 lbs.



## **NON-TIP SMALL CYLINDER STAND - MODEL 470**

This stand offers a convenient method of securing a 3 1/4" cylinder on a table or lab bench. The stand is made of light weight brushed aluminum, yet the large diameter base provides stability even when a regulator is installed on the cylinder.



## **LECTURE BOTTLE HOLDERS**

Lecture bottles have rounded ends and require some means of support when in use. We provide two types of holders here that meet most requirements.

## **NON-TIP STAND - MODEL 475**

This stand offers a convenient method of securing a lecture bottle on a table or lab bench. The stand is made of light weight brushed aluminum, yet the large diameter base provides stability even when a regulator is installed on the bottle.

## **WALL MOUNT LECTURE BOTTLE BRACKET - MODEL 480**

This bracket is made of powder coated steel and has spring steel clips that provide firm, secure support to the lecture bottle. The bracket is ideal for securing lecture bottles to lab cart or bench set-ups, in carrying cases for portable systems, or in storage cabinets



475

480

## **CYLINDER FLOOR STANDS**

### **Series 465**

Available in two and three cylinder models, these floor stands are designed and built to provide safe storage of compressed gas cylinders with diameters up to 12" when a wall, post or bench is not available to secure the cylinder. Fully welded construction from 11 gauge and heavier plate steel and a quality epoxy powder paint finish provide structural integrity and long service life. Surfaces coming in contact with the cylinders are protected with vinyl edge guards. Cylinders are held securely in place with 1.5" polypropylene straps with steel cinch buckles.

#### **HOW TO ORDER**

<b>Model</b>	<b>Description</b>	<b>Dimensions</b>	<b>Weight</b>
465-2	Two cylinder floor stand	28" wide x 30" high x 12" deep	41 lbs
465-3	Three cylinder floor stand	40" wide x 30" high x 12" deep	56 lbs



## **“GAS STATION” PROCESS STANDS**

### **Series 495**

#### **DESCRIPTION**

There are many situations where it would be more convenient to locate gas cylinders and distribution systems near the process, but away from a wall or other secure fixture. The “Gas Station” solves this problem. It can be located in any open area and support two or three cylinders and the associated gas distribution equipment. The stand is secured to the floor with bolts through the four pre-drilled holes provided in the base. Cylinders sit on the base plate and are securely held to the 2”x2” square tubular steel frame painted gray with sturdy nylon belts. A changeover manifold or other distribution equipment can be conveniently mounted to the plate above the cylinders. The unit is shipped unassembled via UPS. Assembly is easily accomplished in 10-15 minutes.

#### **HOW TO ORDER**

---

##### **Model 495-2 Two Cylinder Gas Station**

---

Dimensions: 28” W x 72 1/2” H x 12” D

Weight: 56 pounds

---

---

##### **Model 495-3 Three Cylinder Gas Station**

---

Dimensions: 40” W x 72” H x 12” D

Weight: 78 pounds

---



# CYLINDER STORAGE RACKS

## Series 490

### FEATURES

- Safe cylinder restraint
- Organized gas cylinder storage
- Simple installation
- Uses space efficiently
- Removable and relocatable



### DESCRIPTION

The storage of compressed gas cylinders to comply with Federal, State and Local regulations often presents a number of problems. These new cylinder storage racks can help organize your cylinder storage and help you comply with the myriad of regulations.

Because the frame is predrilled to accommodate anchoring the rack to the floor they are ideal for situations where cylinder must be located away from a wall or other securing fixture. Racks are available in standard sizes to hold one to nine cylinders. Custom racks are available. Standard rack configurations are shown below.

The unique design of square steel tubing (2"x2") components welded together to form the frame provides the rigidity necessary to allow the frame to be constructed without a bottom. This allows cylinders to be rolled into the frame without lifting.

Racks are provided with either single or dual restraint steel chains to secure the cylinders. Single restraint racks secure the individual cylinders with a chain for each cylinder located at the top of the rack. Dual restraint models have a set of chains for each cylinder at 15" and 30" from the floor.

Racks are painted with nitro blue enamel to provide long lasting protection. These cylinder storage racks meet the requirements of the National Fire Protection Association, National Fire Codes, Uniform Fire Codes, Uniform Building Codes and Seismic Zone 4 Restraint Regulations, Compressed Gas Association, and OSHA.

### HOW TO ORDER (other configurations available on request)

Model	Description	Nominal Dimensions
<b>Single restraint models</b>		
490-111	1 cyl wide x 1 cyl deep	16" W x 14" D x 30" H
490-121	2 cyl wide x 1 cyl deep	30" W x 14" D x 30" H
490-131	3 cyl wide x 1 cyl deep	44" W x 14" D x 30" H
490-112	1 cyl wide x 2 cyl deep	16" W x 26" D x 30" H
490-122	2 cyl wide x 2 cyl deep	30" W x 26" D x 30" H
490-132	3 cyl wide x 2 cyl deep	44" W x 26" D x 30" H
490-113	1 cyl wide x 3 cyl deep	16" W x 38" D x 30" H
490-123	2 cyl wide x 3 cyl deep	30" W x 38" D x 30" H
490-133	3 cyl wide x 3 cyl deep	44" W x 38" D x 30" H
<b>Dual Restraint Models</b>		
490-211	1 cyl wide x 1 cyl deep	16" W x 14" D x 30" H
490-221	2 cyl wide x 1 cyl deep	30" W x 14" D x 30" H
490-231	3 cyl wide x 1 cyl deep	44" W x 14" D x 30" H
490-212	1 cyl wide x 2 cyl deep	16" W x 26" D x 30" H
490-222	2 cyl wide x 2 cyl deep	30" W x 26" D x 30" H
490-232	3 cyl wide x 2 cyl deep	44" W x 26" D x 30" H
490-213	1 cyl wide x 3 cyl deep	16" W x 38" D x 30" H
490-223	2 cyl wide x 3 cyl deep	30" W x 38" D x 30" H
490-233	3 cyl wide x 3 cyl deep	44" W x 38" D x 30" H

All cylinder racks must ship motor freight

Gas cylinder restraint and storage

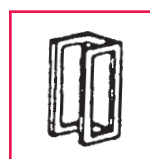

490-111



490-112



490-121

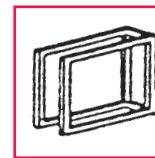

490-113

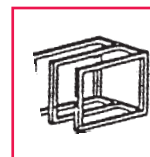

490-123

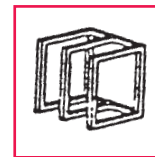

490-122



490-211

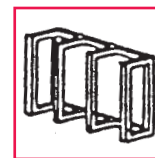

490-131

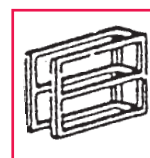

490-213

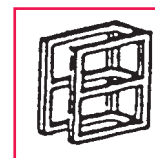

490-212

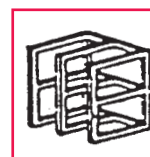

490-222



490-221

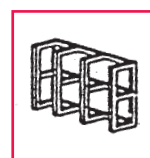

490-231

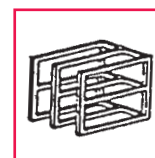

490-223

## **CYLINDER HAND TRUCKS**

These hand trucks are specially designed to hold and easily transport heavy compressed gas cylinders by persons of moderate strength. They feature arc welded tubular steel construction for strength. All models roll quietly and smoothly on large semi-pneumatic or solid rubber tired wheels and casters for better maneuverability over rough or uneven surfaces. Trucks are finished with green, scratch resistant, high gloss, electrostatically applied, oven baked powder coat.

### **MODEL 6114 SINGLE CYLINDER HAND TRUCK**

This unit is designed to handle one T or K type cylinder. It has two 4" rear casters, that fall into place when in use, to provide greater stability. The operator carries no load and has greater control over the truck. The rear wheel assembly is easily returned to the retracted position for storage. The cylinder is held securely on the truck by a safety chain.



### **MODEL 6214 TWO CYLINDER HAND TRUCK**

Designed to handle two T or K type cylinders the 6214 has longer handles for ease of mobility and good load control. Retractable 4" rear casters drop into place when needed for extra load handling safety or collapse and lock into the frame for storage. The truck has dual binding chains for extra security and solid 10" rubber front wheels.



# GAS SAFETY STORAGE CABINETS

## Series 7000

### DESCRIPTION

Gas safety storage cabinets are designed to provide local exhaust gas control to enhance the safety of storing or using hazardous gases. The use of gas cabinets provides a convenient way to achieve separation of gases by their classifications to satisfy both national and local fire and building codes.

When connected to a suitable exhaust system, air is drawn through the cabinet ensuring that any gas leakage is carried away and does not accumulate in the storage or work area. The cabinets can be fitted with manifolds or other gas controls so that both the cylinder and the control system are enclosed. When operators access the controls through the access window and a proper exhaust system is in operation, the cabinet has the capacity to allow 150-200 linear feet per minute of air to pass across the open window face to ensure that workers are not exposed.

### FEATURES

- All welded construction using 11 gauge steel, epoxy painted. Texture finish outside, smooth finish on inside of cabinet.
- Exhaust vent located on top of cabinet is 6" diameter x 3" high.
- 165° F. sprinkler head with bee's wax coating located in cabinet top.
- Cylinder brackets accommodate 7"-9" diameter cylinders. The brackets can move vertically and horizontally for precise pigtail alignment.
- Self-latching and closing window(s) with 1/4" thick wire glass.
- Self-latching and closing door(s) with bottom louvers and flush mounted stainless steel paddle latch(es). Optional keyed latches available.
- All stainless steel fasteners.
- Meets or exceeds the Uniform Fire Code.



### HOW TO ORDER

Model	Description
7100	one cylinder cabinet
7200	two cylinder cabinet
7300	three cylinder cabinet
7400	four cylinder cabinet

OPTIONS:	Model
• Keyed door latch(es)	7000-1
• Keyed window latch(es)	7000-2
• Adjustable small cylinder shelf	7000-3

### CABINET PHYSICAL DATA

Model	Cylinder Capacity	Dimensions* Outside	Door Opening	Weight	Exhaust Flow Required (SCFM)
7100	one	18"w x 18"d x 72"h	16"w x 70"h	235 lbs.	175
7200	two	24"w x 18"d x 72"h	22"w x 70"h	283 lbs.	250
7300	three	36"w x 18"d x 72"h	left 22"w x 70"h right 16"w x 70"h	331 lbs.	450
7400	four	48"w x 18"d x 72"h	left 22"w x 70"h right 22"w x 70"h	391 lbs.	600

\*Overall cabinet height including exhaust vent is 75".

## ***SPECIAL CYLINDER WRENCHES***

### **MODEL 90001**

This universal cylinder wrench has 3 openings on one end (11/16", 1-1/8", 1-1/4") for tightening the various cylinder valve connections and most commonly used gas connections. The opposite end has a 3/8" square box for opening cylinder valves that do not have hand wheels.



### **MODEL 90002**

This wrench is a basic 3/8" square for opening cylinder valves that do not have hand wheels, such as chlorine and hydrogen sulfide.



### **MODEL 90003**

The special configuration of this wrench provides an easy method of opening extra tight, hand wheel operated cylinder valves and removing difficult cylinder caps.

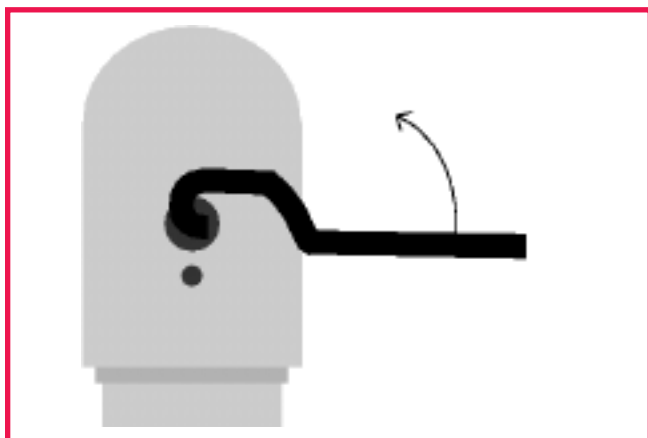

**Remove difficult cylinder caps**

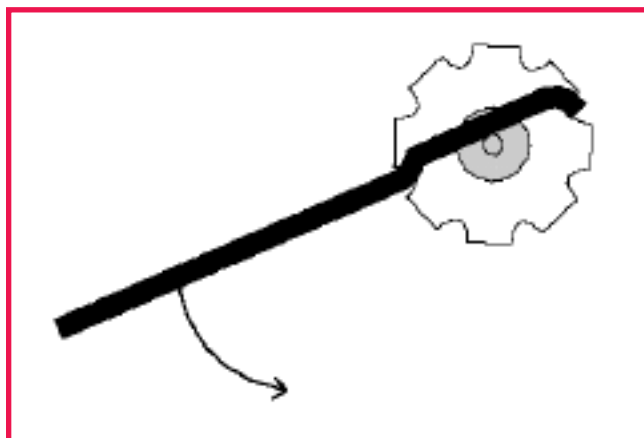

**Open tight valves easily**

## 316 STAINLESS STEEL FLEXIBLE HOSES Series 601, 602, 604, and 605

### DESCRIPTION

Series 601 hoses are constructed of 1/4" I.D. teflon® lined stainless steel braid, rated for 3000 psig. The 601 hoses are fitted with 1/4" NPT brass end connections; they make excellent economical manifold pigtailed. The 602 hoses are fitted with 1/4" NPT stainless steel end connections.

The Series 604 hoses are constructed of double braided stainless steel, fitted with stainless steel 1/4" NPT end connections, rated for 3000 psig, and cleaned for oxygen service.

### SERIES 601 AND 602

- 1/4" I.D. Teflon® lined 316 stainless steel braided hose
- Rated for 3000 psig
- 601 1/4" NPT female x 1/4" NPT female  
 601M 1/4" NPT male x 1/4" NPT male  
 601MF 1/4" NPT male x 1/4" NPT female
- 602 1/4" NPT female x 1/4" NPT female  
 602M 1/4" NPT male x 1/4" NPT male  
 602MF 1/4" NPT male x 1/4" NPT female
- Cleaned for oxygen service.

### HOW TO ORDER

Model	Length	Model	Length	Model	Length
601-2	2.0 feet	602-3	3.0 feet	604-6	6.0 feet
601M-2	2.0 feet	602M-3	3.0 feet	604M-6	6.0 feet
601MF-2	2.0 feet	602MF-3	3.0 feet	604MF-6	6.0 feet
601-3	3.0 feet	602-6	6.0 feet	605-2	2.0 feet
601M-3	3.0 feet	602M-6	6.0 feet	605M-2	2.0 feet
601MF-3	3.0 feet	602MF-6	6.0 feet	605MF-2	2.0 feet
601-6	6.0 feet	604-2	2.0 feet	605-3	3.0 feet
601M-6	6.0 feet	604M-2	2.0 feet	605M-3	3.0 feet
601MF-6	6.0 feet	604MF-2	2.0 feet	605MF-3	3.0 feet
602-2	2.0 feet	604-3	3.0 feet	605-6	6.0 feet
602M-2	2.0 feet	604M-3	3.0 feet	605M-6	6.0 feet
602MF-2	2.0 feet	604MF-3	3.0 feet	605MF-6	6.0 feet



### SERIES 604 AND 605

- 1/4" I.D. 316 stainless steel double braided hose (605 Series has protective outer armor to provide greater safety and kink resistance.)
- Rated for 3000 psig
- 1/4" NPT female or male stainless steel end connections
- Cleaned for oxygen service.

### SPECIAL HOSES

We can provide any of the hoses on this page in different lengths and with a wide variety of end fittings.

## CRYOGENIC TRANSFER HOSES – Series 607C

- 1/2" I.D. 316 stainless steel double braided hose with protective outer armor to provide greater safety and kink resistance
- Rated for 2150 psig
- 1/2" 45° flare female stainless steel connections (CGA 295) or 5/8" 45° flare (CGA 440) for oxygen
- Cleaned for oxygen service.

### HOW TO ORDER

Model	Length
607C-4 for nitrogen and argon	4.0 feet
607C-6 for nitrogen and argon	6.0 feet
607C-4-440 for oxygen	4.0 feet
607C-6-440 for oxygen	6.0 feet

### SPECIAL HOSES

We can provide any of the hoses on this page in different lengths and with a wide variety of end fittings.



## **SILENCED CRYOGENIC SAFETY RELIEF VALVE**

### **Series 8636 Whisper Valve™**

#### **DESCRIPTION**

The Whisper Valve is a silenced safety device for use with cryogenic containers.

The valve solves the problem of the loud noise, over 100 dB, associated with the activation of the relief valve in cryogenic containers containing nitrogen, argon or carbon dioxide. Many users of gas in cryogenic containers complain to their suppliers that the loud activation noise scares their employees and causes work disruptions and results in damaged product.

The Whisper Valve is easily installed on the vent valve of any cryogenic container and silently relieves the container pressure slightly below the normally installed relief valve. Whisper Valve reduces the relief of gas pressure at a noise level of less than 40 dB, for reference the average library noise level is 30 dB.

The Whisper Valve also reduces the gas losses of your cryogenic container to less than 48 cubic feet over 24 hours.

Whisper Valves are available in three settings, 230 psig, 350 psig, and 500 psig.

#### **FEATURES**

- Reduces cryogenic relief valve blow-off noise to less than 40 dB
- Easily installs on any cryogenic argon, nitrogen or carbon dioxide container
- Available in three ranges to prevent most container noisy blow-offs
- Reduces gas losses to less than 48 cubic feet per 24 hours
- Convenient wall mount kit available
- Standard CGA 295 inlet connection



Patent Pending



#### **HOW TO ORDER**

<b>Model Number</b>	<b>Description</b>
8636-230	Whisper valve for cryogenic containers with 230 or 235 psig relief setting
8636-350	Whisper valve for cryogenic containers with 350 psig relief setting
8636-500	Whisper valve for cryogenic containers with 500 psig relief setting
8636-KIT	Wall mount bracket, panel mount nut, and six-foot hose with CGA 295

**WHISPER VALVE TAKES THE POP OUT OF CRYOGENIC SAFETIES**

# SPARGERS

## Series 050-70000

### DESCRIPTION

The Series 050-70000 spargers are used to inject an inert gas into a wide variety of liquefied foodstuffs during processing. The sparging technique preserves product quality by flushing out oxygen. The sparging process also fluffs and carbonates the product by super saturating it with tiny gas bubbles. Nitrogen, carbon dioxide, nitrous oxide, or argon are generally the gases of choice for this process.

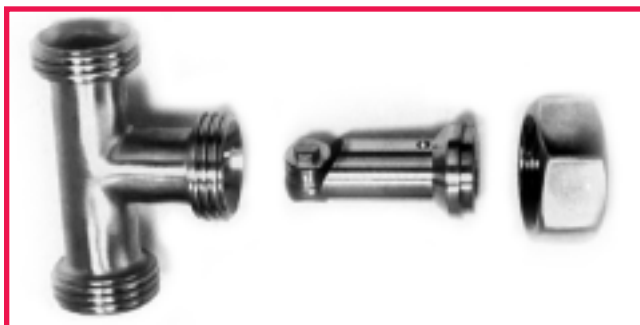

### FEATURES

- Unique infuser design assures optimum sparging results.
- Tee design permits easy removal of infuser assembly for cleaning.
- Available in four sizes 1", 1-1/2", 2", and 3".
- Constructed of 304 stainless steel with either ACME threads of quick-clamp sanitary fittings for the food processing industry. (Other connection types available on request).
- Complete spargers and infuser assemblies available.

### HOW TO ORDER

Complete Assemblies	1"	1 1/2"	2"	3"
Complete Sparger with ACME threads	050-71000	050-71500	050-72000	050-73000
Complete Sparger with quick-clamp sanitary fittings	050-71000TR	050-71500TR	050-72000TR	050-73000TR
Complete Infuser	050-71008	050-71508	050-72008	050-73008

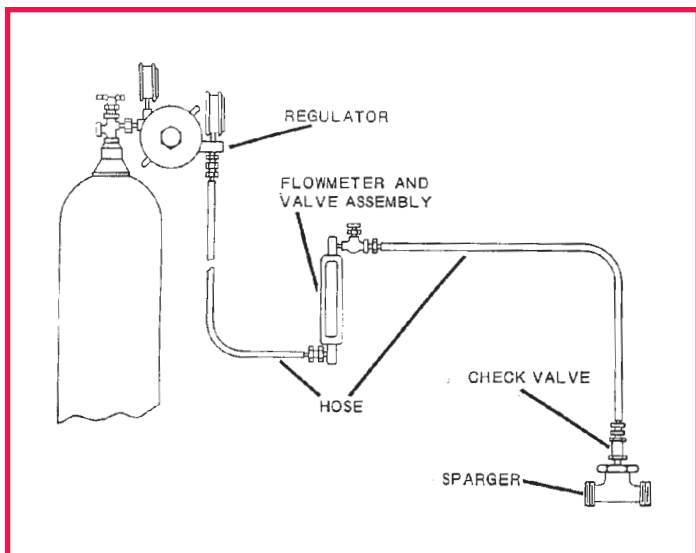

#### Typical sparger installation.

All components are available. Selection is dependent on actual application and sparger size.

## PRESSURE GAUGES



### DESCRIPTION

The selection of brass, stainless steel, and monel® gauges presented here represent those used on pressure regulators offered in this catalog. They can be used as repair parts or for installation in other systems.

### FEATURES

- 1/4" NPT lower male connection.
- Cleaned for oxygen service - brass and stainless steel only.

### HOW TO ORDER

#### BRASS WITH BRASS CASE - 2 1/2" DIA.

Model	Pressure Range - psi
9131-4PM-0015	0-15
9131-4PM-0030	0-30
9131-4PM-0060	0-60
9131-4PM-0100	0-100
9131-4PM-0200	0-200
9131-4PM-0400	0-400
9131-4PM-1000	0-1000
9131-4PM-2000	0-2000
9131-4PM-4000	0-4000
9131-4PM-6000	0-6000
9131-4PM-7500	0-7500

#### 316 STAINLESS STEEL WITH STAINLESS STEEL CASE - 2 1/2" DIA.

Model	Pressure Range - psi
9132-4PM-3030	30" 0-30
9132-4PM-0030	0-30
9132-4PM-0060	0-60
9132-4PM-0100	0-100
9132-4PM-0200	0-200
9132-4PM-0400	0-400
9132-4PM-1000	0-1000
9132-4PM-2000	0-2000
9132-4PM-3000	0-3000
9132-4PM-6000	0-6000
9132-4PM-10000	0-10000

#### MONEL® WITH STAINLESS STEEL CASE - 2 1/2" DIA.

Model	Pressure Range - psi
9133-4PM-0100	0-100
9133-4PM-0300	0-300
9133-4PM-1000	0-1000
9133-4PM-3000	0-3000

Other sizes and ranges available.

## GAUGES WITH FACE SEAL FITTINGS

### DESCRIPTION

On some high purity regulators the gauges are connected to the regulator body by using face seal fittings rather than NPT threads.

### FEATURES

- 1/4" female face seal connection
- Dual scale dial psig/bar
- Cleaned for oxygen service

### HOW TO ORDER

316 stainless steel with stainless steel case 2" dia.

Model	pressure range
9122-4VM-3030	30" vac.- 0-30 psig (-1.0 - 2 bar)
9122-4VM-3060	30" vac.- 0-60 psig (-1.0 - 4 bar)
9122-4VM-3100	30" vac. - 0-100 psig (-1.0 - 7 bar)
9122-4VM-0200	0-200 psig (0-14 bar)
9122-4VM-0400	0-400 psig (0-28 bar)
9122-4VM-1000	0-1000 psig (0-70 bar)
9122-4VM-4000	0-4000 psig (0-280 bar)

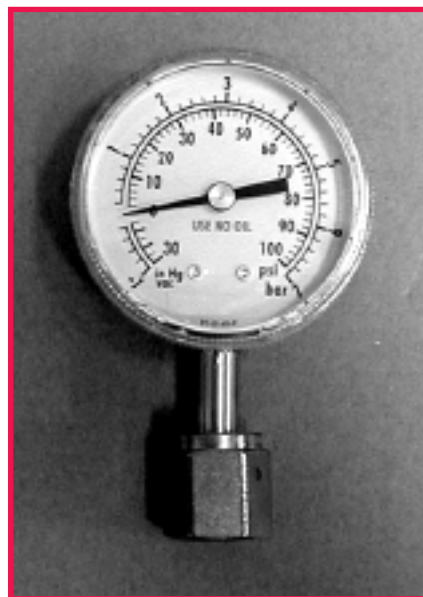

## CGA CYLINDER CONNECTIONS



### DESCRIPTION

The standard cylinder connections shown in the table below convert CGA cylinder valve outlets to 1/8" NPT male, or 1/4" NPT male, or 1/4" face seal male.

Caution: When changing the gas service of a regulator or gas system by changing the cylinder connections, the regulator or system must be thoroughly cleaned prior to the introduction of the new gas. It is strongly recommended that you consult with your supplier before attempting any conversion to confirm that the intended conversion can indeed be performed safely, or that such equipment be returned to your supplier for conversion.

### HOW TO ORDER

Order by CGA No. and description, i.e. "CGA 350 brass cylinder connection". "X" indicates availability.

CGA No.	Chrome Brass	Brass 1/4" NPT	St. St. 1/4" NPT	St. St. 1/4" Face Seal	Monel® 1/4" NPT
170	X*	X*	X*	—	—
180	X*	X*	X*	—	X*
240	—	—	X	—	—
280	—	X	X	—	—
290	—	—	X	—	—
296	X	X	—	X	—
300	—	X	—	—	—
320	X	X	X	—	—
326	X	X	X	X	—
330	—	X	X	X	X
346	X	X	X	—	—
347	—	—	X	—	—
350	X	X	X	X	—
510	X	X	X	X	—
540	X	X	X	X	—
580	X	X	X	X	—
590	X	X	X	X	—
626	—	—	X	—	—
660	—	X	X	X	X
670	—	—	X	X	X
677	—	—	X	—	—
678	—	—	X	X	—
679	—	—	X	X	X
680	—	X	X	—	—
695	—	X	X	—	—
702	—	—	X	—	—
703	—	X	X	—	—
705	—	—	X	—	—

\*Fitting has 1/8" NPT male instead of 1/4" NPT male

## CGA CONNECTIONS GASKETS

Some standard connections and all DISS connections require a gasket to achieve a leak-free connection. Gaskets should be changed each time the connection is attached to the cylinder valve.

### HOW TO ORDER

Model	Description
CGA110WA	Teflon gasket for CGA 110 & 679
CGA170WA	Teflon gasket for CGA 170
CGA180WA	Teflon gasket for CGA 180
CGA 240 WA	Teflon gasket for CGA 240
CGA320/330WA	Teflon gasket for CGA 320 & 330
CGA660/670WA	Teflon gasket for CGA 660 & 670
CGA 678/680WA	Teflon gasket for CGA 678 & 680
CGA679PB	Lead washer for CGA 679
CGA 705WA	Teflon gasket for CGA 705
DISS-NI	Nickel gasket for CGA 632 thru 726
DISS-K	Kel-F gasket for CGA 632 thru 726

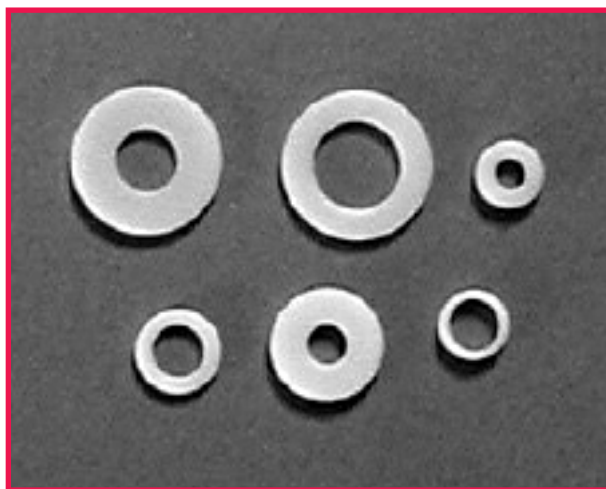

## UHP (DISS) CYLINDER CONNECTIONS

### DESCRIPTION

This special group of cylinder connections was developed through the cooperation of industry and the Compressed Gas Association for use with ultra purity gases primarily used in conjunction with semiconductor chip manufacturing applications. The sealing surfaces are similar to a face seal connection used with tubing and they require either a nickel gasket or Kel-F gasket to achieve a seal. They are only available in stainless steel.

### FEATURES

- Available with in three mating connection styles
  - 1/4" face seal male
  - 1/4" NPT male
  - 1/4" tube stub
- Supplied as a set nut, nipple, and nickel gasket



### DISS GASKETS

All DISS connections require a gasket to achieve a leak-free connection. Gaskets should be changed each time the connection is attached to the cylinder valve.

### HOW TO ORDER

Model	Description
DISS-NI	Nickel gasket for CGA 632 thru 726
DISS-K	Kel-F gasket for CGA 632 thru 726

### HOW TO ORDER

Model	Description
DISS632-P4M	632 x 1/4" NPT male
DISS632-V4M	632 x 1/4" male face seal
DISS632-T4S	632 x 1/4" tube stub
DISS634-P4M	634 x 1/4" NPT male
DISS634-V4M	634 x 1/4" male face seal
DISS634-T4S	634 x 1/4" tube stub
DISS636-P4M	636 x 1/4" NPT male
DISS636-V4M	636 x 1/4" male face seal
DISS636-T4S	636 x 1/4" tube stub
DISS638-P4M	638 x 1/4" NPT male
DISS638-V4M	638 x 1/4" male face seal
DISS638-T4S	638 x 1/4" tube stub
DISS640-P4M	640 x 1/4" NPT male
DISS640-V4M	640 x 1/4" male face seal
DISS640-T4S	640 x 1/4" tube stub
DISS642-P4M	642 x 1/4" NPT male
DISS642-V4M	642 x 1/4" male face seal
DISS642-T4S	642 x 1/4" tube stub
DISS712-P4M	712 x 1/4" NPT male
DISS712-V4M	712 x 1/4" male face seal
DISS712-T4S	712 x 1/4" tube stub
DISS714-P4M	714 x 1/4" NPT male
DISS714-V4M	714 x 1/4" male face seal
DISS714-T4S	714 x 1/4" tube stub
DISS716-P4M	716 x 1/4" NPT male
DISS716-V4M	716 x 1/4" male face seal
DISS716-T4S	716 x 1/4" tube stub
DISS718-P4M	718 x 1/4" NPT male
DISS718-V4M	718 x 1/4" male face seal
DISS718-T4S	718 x 1/4" tube stub
DISS720-P4M	720 x 1/4" NPT male
DISS720-V4M	720 x 1/4" male face seal
DISS720-T4S	720 x 1/4" tube stub
DISS722-P4M	722 x 1/4" NPT male
DISS722-V4M	722 x 1/4" male face seal
DISS722-T4S	722 x 1/4" tube stub
DISS724-P4M	724 x 1/4" NPT male
DISS724-V4M	724 x 1/4" male face seal
DISS724-T4S	724 x 1/4" tube stub
DISS726-P4M	726 x 1/4" NPT male
DISS726-V4M	726 x 1/4" male face seal
DISS726-T4S	726 x 1/4" tube stub

# GAS SAFETY AND MATERIAL COMPATIBILITY DATA CHART

This data has been compiled from the best information available and is offered as a guide to proper material selection. The data presented are generalized for average conditions of temperature and pressure. The user should always investigate the characteristics of the gas being handled and take all the proper precautions. Our technical staff will be pleased to give free advice and technical information on any gas or chemical product of interest.

GAS	HAZARDS FOR HUMANS			MATERIALS OF CONSTRUCTION								SPECIAL CHARACTERISTICS
	Toxic	Flammable	Corrosive	Aluminum	Copper	Brass	Steel	Stainless Steel	Monel®	Kel-F®	Teflon®	
Acetylene		◇		R	N	R	R	R		R	R	Do not use at pressures exceeding 15psig
Air				R	R	R	R	R	R	R	R	
Ammonia	◇	◇	◇	R	N	N	X	R		R	R	Causes stress cracking of copper and copper alloys
Argon				R	R	R	R	R		R	R	
Arsine*	◇	◇		X	N	X	X	R		R	R	Highly toxic, excessive exposure may have delayed effect
Boron Trichloride	◇		◇	N	X	X	X	X	X	R	R	
Boron Trifluoride	◇		◇	X	R	R	R	R	R	R	R	
1-3, Butadiene		◇		R	R	R	R	R		R	R	
Butane		◇		R	R	R	R	R		R	R	
Butenes		◇		R	R	R	R	R		R	R	
Carbon Dioxide				R	R	R	R	R		R	R	
Carbon Monoxide	◇	◇		R	R	R	R	R		R	R	
Carbonyl Sulfide	◇	◇		R	N	N	X	R		R	R	Treat as Hydrogen Sulfide, affects central nervous system
Chlorine	◇		◇	N	N	N	X	X	X	R	R	Very toxic and damaging to the respiratory system
Cyanogen*	◇	◇		X			R	R		R	R	Treat as cyanides
Deuterium		◇		R	R	R	R	R		R	R	
Dimethylamine	◇	◇	◇	X	N	N	R	R		X	R	Attacks copper and copper alloys rapidly.
Dimethyl Ether		◇		R	R	R	R	R		R	R	
Ethane		◇		R	R	R				R	R	
Ethyl Chloride	◇	◇				R	R	R		R	R	
Ethylene		◇		R	R	R	R	R		R	R	
Ethylene Oxide	◇	◇			N	N	R	R		R	R	Exposure of liquid on skin or clothing can cause dermatitis
Fluorine*	◇		◇	R	R	X		R	R	N	X	Strong oxidant, can ignite combustible materials and metals
Helium				R	R	R	R	R		R	R	
Hydrogen		◇		R	R	R	R	R		R	R	
Hydrogen Bromide	◇		◇	N	X	N	X	X	X	R	R	Steel or stainless steel serviceable in dry liquid or gas service
Hydrogen Chloride	◇		◇	N	X		X	X	X	R	R	Steel or stainless steel serviceable in dry liquid or gas service
Hydrogen Fluoride*	◇		◇	X	R	R	R	R		R	R	Exposure can attack skin, bones and fingernails
Hydrogen Selenide	◇	◇		N	N	N	X	R		R	R	Extremely toxic, odor deadens the olfactory nerves
Hydrogen Sulfide*	◇	◇		N	N	N	X	R		R	R	Odor deadens olfactory nerves, can cause paralysis
Isobutane		◇		R	R	R	R	R		R	R	
Isobutylene		◇		R	R	R	R	R		R	R	
Krypton				R	R	R	R	R		R	R	

\*It is recommended that users thoroughly familiarize themselves with the specific properties of this gas.

LEGEND	
◇ - Primary Hazard	N - Not Recommended
R - Recommended	X - Depends on conditions

# GAS SAFETY AND MATERIAL COMPATIBILITY DATA CHART

GAS	HAZARDS FOR HUMANS			MATERIALS OF CONSTRUCTION								SPECIAL CHARACTERISTICS
	Toxic	Flammable	Corrosive	Aluminum	Copper	Brass	Steel	Stainless Steel	Monel®	Kel-F®	Teflon®	
Methane	◇	◇		R	R	R	R	R		R	R	
Methyl Acetylene		◇		R	N	X	R	R		R	R	
Methyl Bromide	◇	◇		X	R	R	R	R		R	R	
Methyl Chloride	◇	◇		N	X	R	R	R		R	R	Forms explosive compounds with aluminum
Methyl Mercaptan	◇	◇		R	N	X	R	R		R	R	
Monoethylamine	◇	◇		X	N	N	R	R		X	R	Attacks copper and copper alloys rapidly
Monomethylamine	◇	◇		X	N	N	R	R		X	R	Attacks copper and copper alloys rapidly
Neon				R	R	R	R	R		R	R	
Nitric Oxide	◇		◇	R	N	N	X	R	N	R	R	Readily reacts with Oxygen to form Nitrogen Dioxide
Nitrogen				R	R	R	R	R		R	R	
Nitrosyl Chloride	◇		◇	N	N	N	N	N	R		R	Very corrosive, attacks most metals except nickel
Nitrous Oxide				R	R	R	R	R		R	R	
Oxygen*				R	R	R	R	R		R	R	Strong oxidant, ignites combustible matter spontaneously
Phosgene	◇		◇	N	N	N	X	X	R	R	R	Very toxic
Phosphine*	◇	◇		R	X	X	R	R		R	R	Highly toxic, high concentrations are pyrophoric
Propane		◇		R	R	R	R	R		R	R	
Propylene		◇		R	R	R	R	R		R	R	
Silane*	◇	◇		R	R	R	R	R		R	R	Pyrophoric
Silicon Tetrafluoride	◇		◇	R	R	R	R	R		R	R	
Sulfur Dioxide	◇		◇	R	R	R	R	R		R	R	
Sulfur Hexafluoride				R	R	R	R	R		R	R	
Sulfur Tetrafluoride	◇		◇	R	R	R	R	R		R	R	
Trimethylamine	◇	◇		R	N	N	R	R		X	R	Attacks copper and copper alloys rapidly
Xenon				R	R	R	R	R		R	R	

\*It is recommended that users thoroughly familiarize themselves with the specific properties of this gas.

All data presented are considered accurate and reliable but supplier assumes no liability or responsibility of any kind.

LEGEND	
◇ - Primary Hazard	N - Not Recommended
R - Recommended	X - Depends on conditions

## NUMERICAL INDEX

<b>Model or Series</b>	<b>Page</b>	<b>Model or Series</b>	<b>Page</b>
PS-2 .....	94	3900 Series .....	24
3-033-R002 .....	95	3910 Series .....	24
LT-8 .....	30	3920 Series .....	22
LT-1G .....	30	3990 Series .....	25
050-70000 .....	106	3991 Series .....	25
HB120 .....	61	3992 Series .....	25
320 Series .....	64	3993 Series .....	25
400 Series .....	96	4500 Series .....	81
420 Series .....	96	4600 Series .....	81
450 Series .....	97	4800 Series .....	80
460 Series .....	97	5000 Series .....	54
465 Series .....	98	5100 Series .....	54
470 Series .....	97	5200 Series .....	54
475 Series .....	25, 97	6114 Series .....	101
480 Series .....	25, 97	6200 Series .....	47
490 Series .....	100	6210 Series .....	48
495 Series .....	99	6214 Series .....	101
601 Series .....	104	6250 Series .....	47
602 Series .....	104	6284 Series .....	60
604 Series .....	104	6300 Series .....	46
605 Series .....	104	6400 Series .....	49
607C Series .....	104	7000 Series .....	102
620G Series .....	64	7100 Series .....	55
810C Series .....	40	7130 Series .....	58
820 Series .....	42	7140 Series .....	58
900 Series .....	65	7300 Series .....	56
910 Series .....	68	7500 Series .....	60
911 Series .....	69	7900 Series .....	39
912 Series .....	76	7920 Series .....	32-33
914 Series .....	27, 72	7920B Series .....	33, 36
916 Series .....	73	7923 Series .....	37
917 Series .....	27, 74	7940 Series .....	35
918 Series .....	27, 70	7941 Series .....	35
920 Series .....	68	7950 Series .....	34
921 Series .....	69	7965 Series .....	36
1000 Series .....	62	7974 Series .....	38
2700 Series .....	22	7975 Series .....	38
2720 Series .....	23	8000 Series .....	45
EZ3000 .....	85	8010 Series .....	44
3100 Series .....	4	8012 Series .....	50
3101L Series .....	12	8020 Series .....	50
3200 Series .....	5	8040 Series .....	50
HL3300 Series .....	28	8050 Series .....	50
3400 Series .....	6	8060 Series .....	51
3401L Series .....	13	8100 Series .....	82
3450 Series .....	8	8200 Series .....	52
3451L Series .....	14	8300 Series .....	83
3460 Series .....	10	8400 Series .....	82
3461L Series .....	15	8490 Series .....	66
3470 Series .....	17	8500 Series .....	85
3500 Series .....	7	8600 Series .....	84
3550 Series .....	9	8636 Series .....	105
3560 Series .....	11	9122 Series .....	107
3600 Series .....	29	9131 Series .....	107
3650 Series .....	14	9132 Series .....	107
3660 Series .....	15	9133 Series .....	107
3700 Series .....	18, 19	9900 Series .....	77
3800V Series .....	20	90001 Series .....	103
3830 Series .....	16	90002 Series .....	103
3850 Series .....	26	90003 Series .....	103
3860T Series .....	21		